

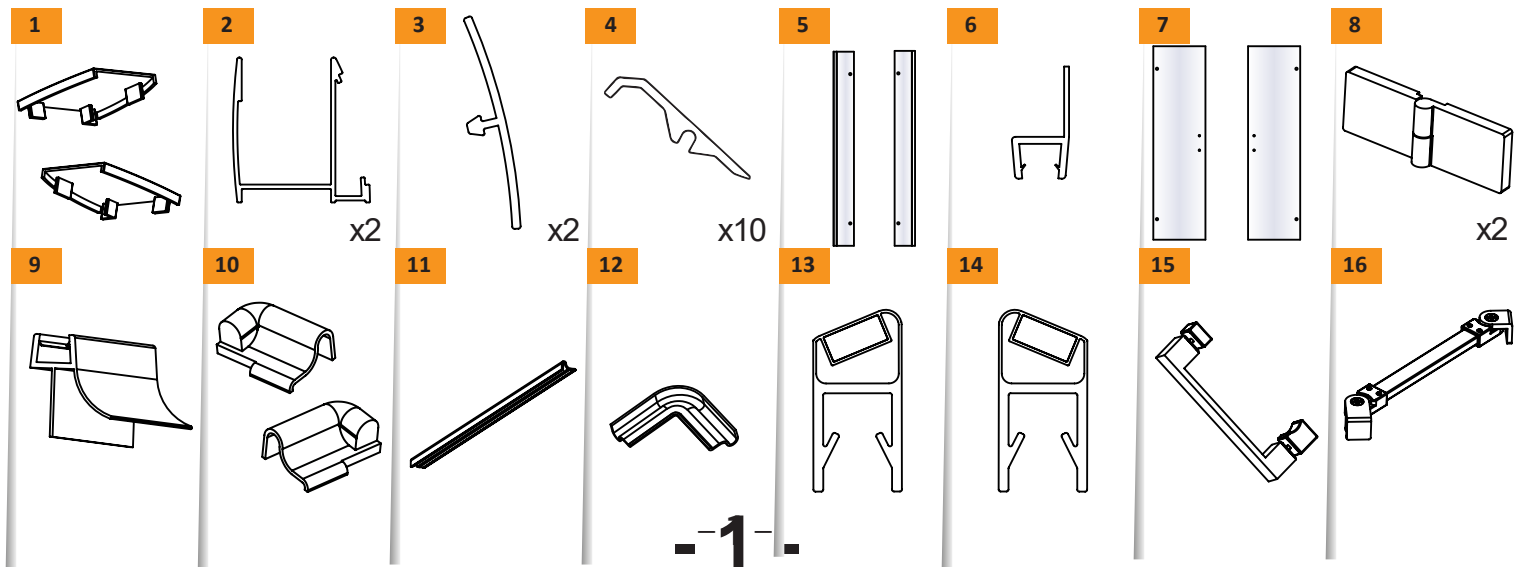

NEW RENOMA

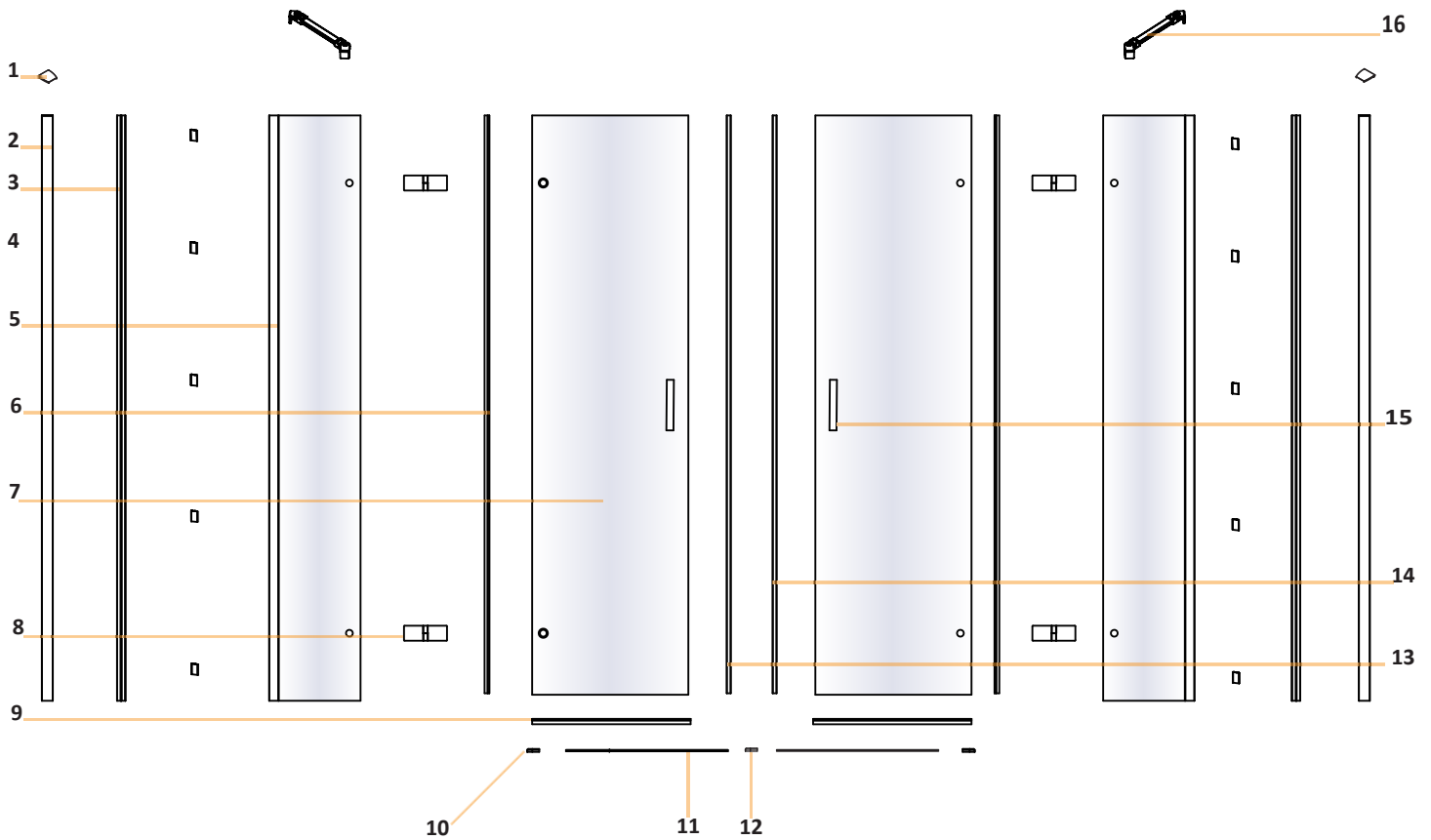

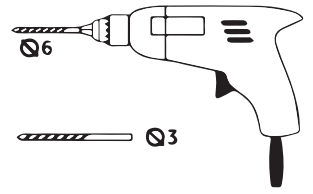
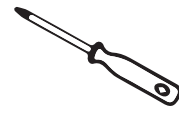
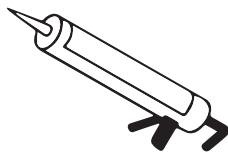
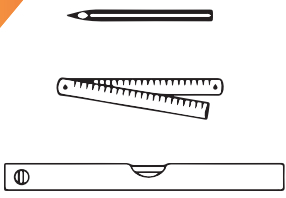

1

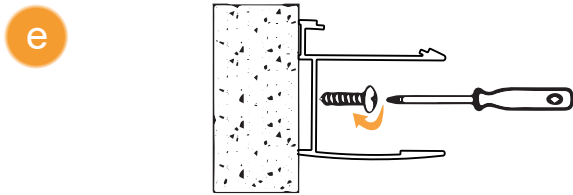
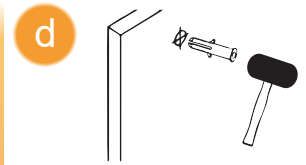
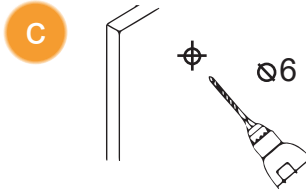
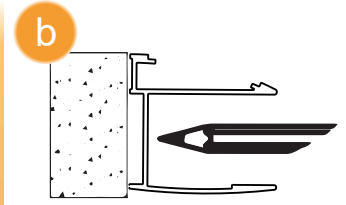
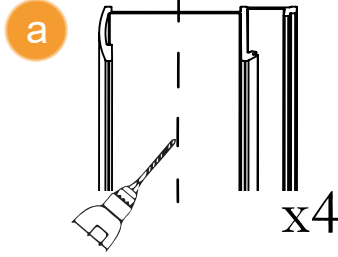
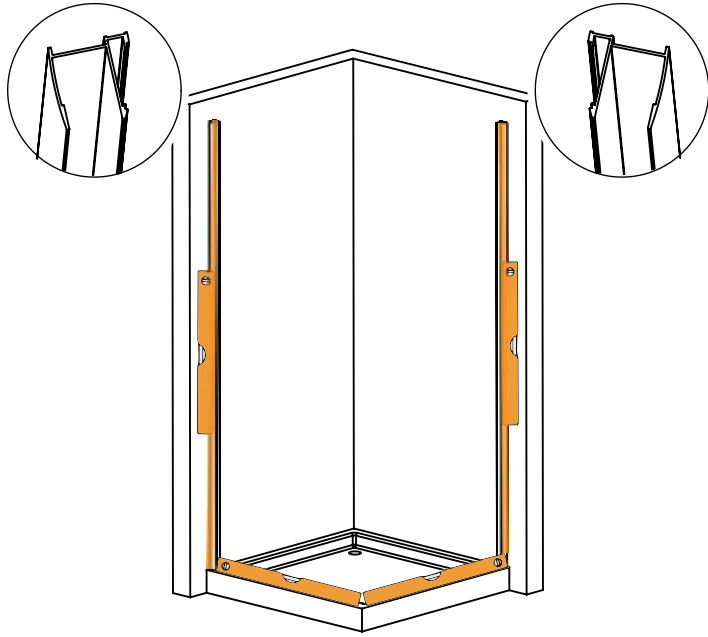

2

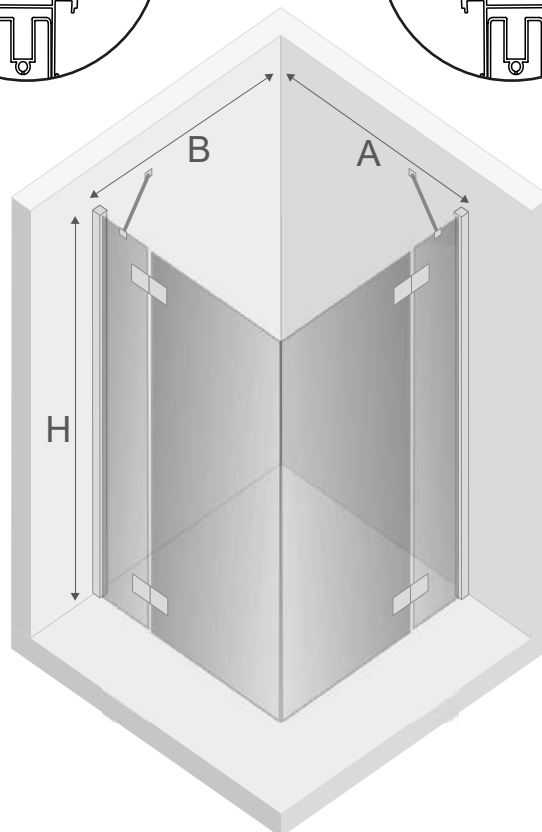
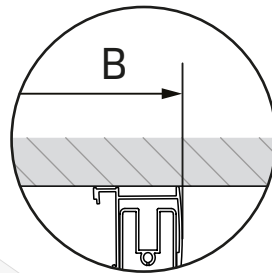
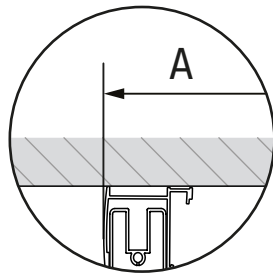



TABELA NIE DOTYCZY KABIN NA WYMIAR!
THE TABLE DOES NOT INCLUDE CUSTOM-MADE ENCLOSURES!

Specyfikacja techniczna **Kabin Na Wymiar** znajduje się w potwierdzeniu zamówienia.
The technical specification of the **Custom-Made Cabin** can be found in the order confirmation.

	Wymiary gabarytowe Overall dimensions		Wymiary do osi szyby Dimensions to the pane axis	
	A	B	X1	X2
80x80x195	79-80,5	79-80,5	77,7-79,2	77,7-79,2
80x90x195	79-80,5	89-90,5	77,7-79,2	87,7-89,2
80x100x195	79-80,5	99-100,5	77,7-79,2	97,7-99,2
80x110x195	79-80,5	109-110,5	77,7-79,2	107,7-109,2
80x120x195	79-80,5	119-120,5	77,7-79,2	117,7-119,2
90x80x195	89-90,5	79-80,5	87,7-89,2	77,7-79,2
90x90x195	89-90,5	89-90,5	87,7-89,2	87,7-89,2
90x100x195	89-90,5	99-100,5	87,7-89,2	97,7-99,2
90x110x195	89-90,5	109-110,5	87,7-89,2	107,7-109,2
90x120x195	89-90,5	119-120,5	87,7-89,2	117,7-119,2
100x80x195	99-100,5	79-80,5	97,7-99,2	77,7-79,2
100x90x195	99-100,5	89-90,5	97,7-99,2	87,7-89,2
100x100x195	99-100,5	99-100,5	97,7-99,2	97,7-99,2

	Wymiary gabarytowe Overall dimensions		Wymiary do osi szyby Dimensions to the pane axis	
	A	B	X1	X2
100x110x195	99-100,5	109-110,5	97,7-99,2	107,7-109,2
100x120x195	99-100,5	119-120,5	97,7-99,2	117,7-119,2
110x80x195	109-110,5	79-80,5	107,7-109,2	77,7-79,2
110x90x195	109-110,5	89-90,5	107,7-109,2	87,7-89,2
110x100x195	109-110,5	99-100,5	107,7-109,2	97,7-99,2
110x110x195	109-110,5	109-110,5	107,7-109,2	107,7-109,2
110x120x195	109-110,5	119-120,5	107,7-109,2	117,7-119,2
120x80x195	119-120,5	79-80,5	117,7-119,2	77,7-79,2
120x90x195	119-120,5	89-90,5	117,7-119,2	87,7-89,2
120x100x195	119-120,5	99-100,5	117,7-119,2	97,7-99,2
120x110x195	119-120,5	109-110,5	117,7-119,2	107,7-109,2
120x120x195	119-120,5	119-120,5	117,7-119,2	117,7-119,2

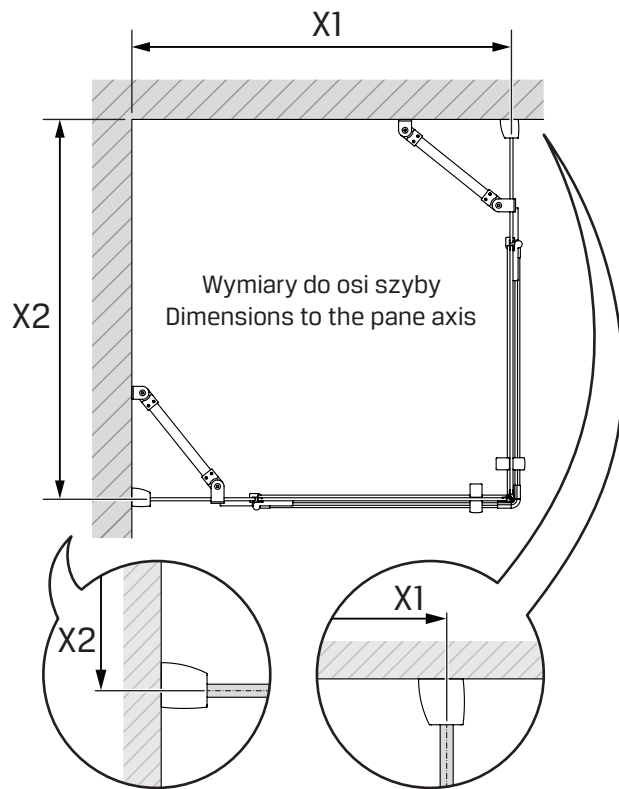
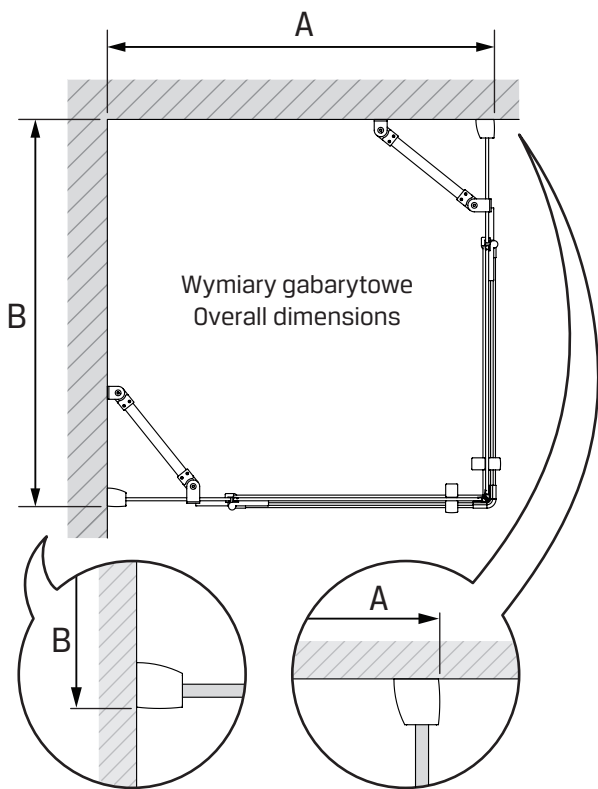
3



INSIDE

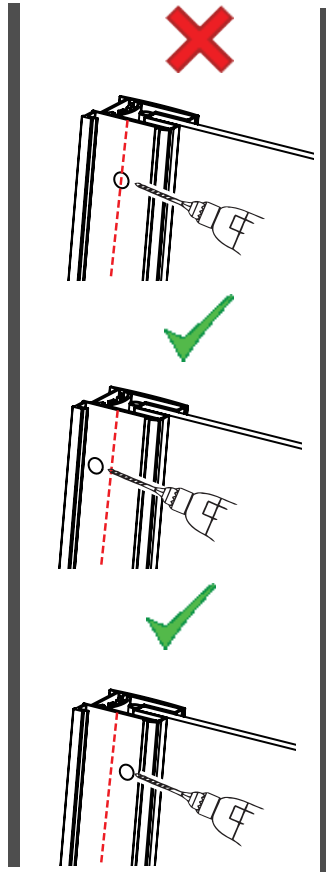
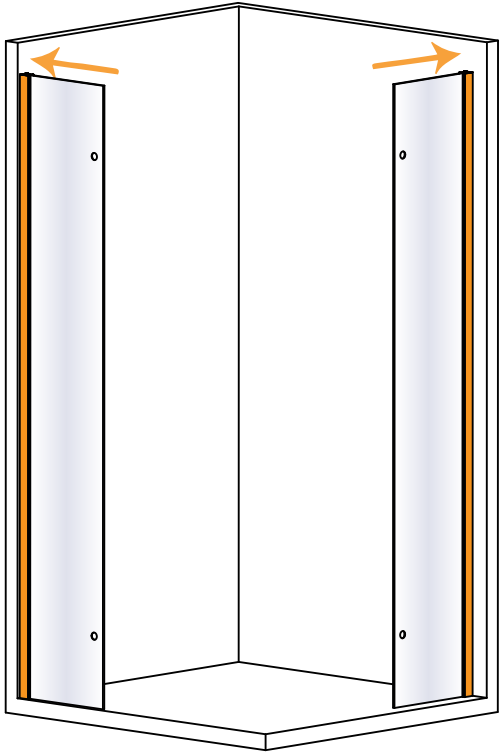

a

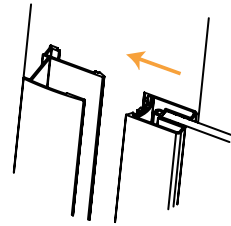

b

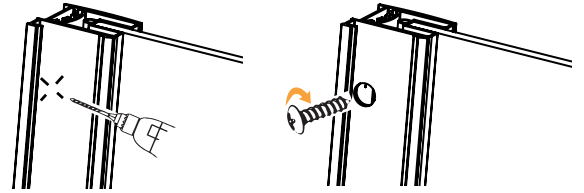

c

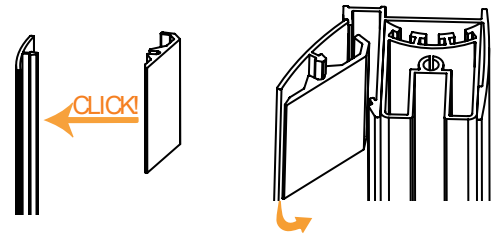

4

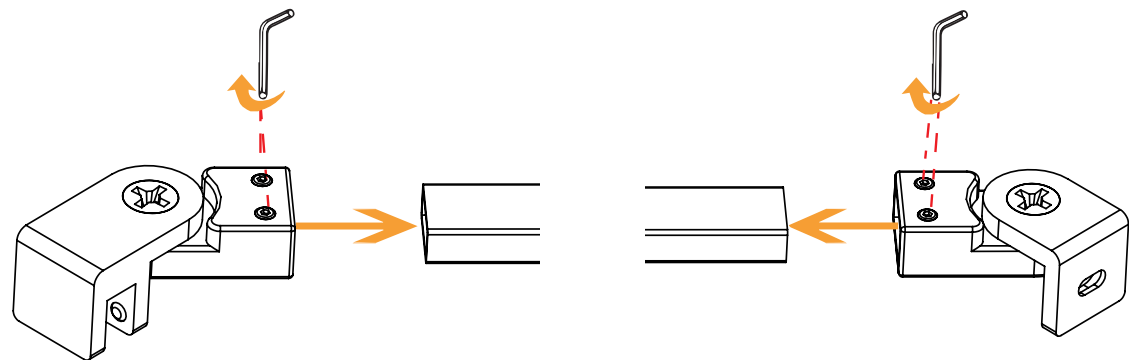
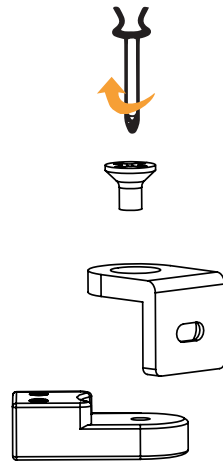
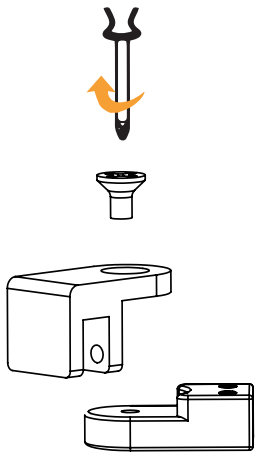

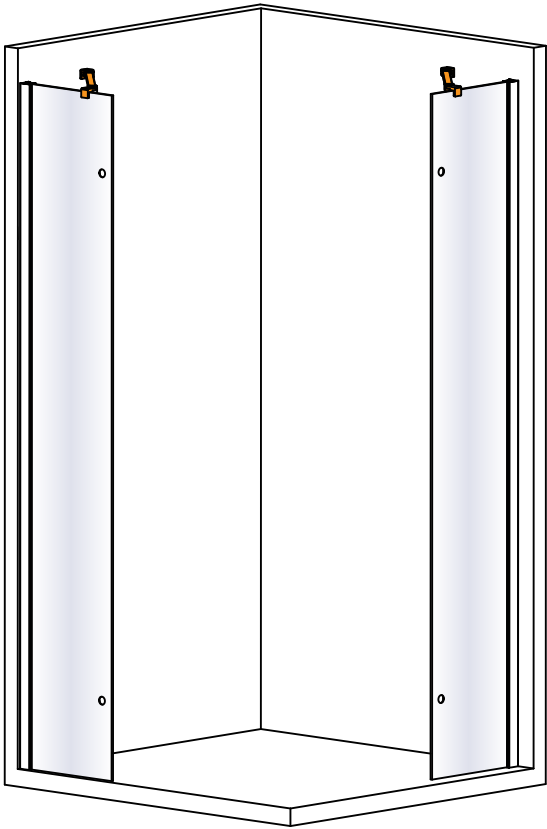
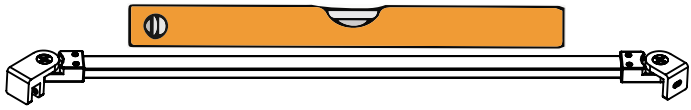

a

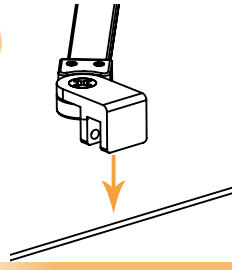

b

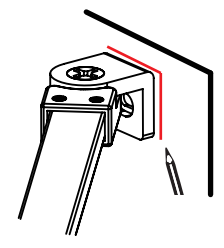

c

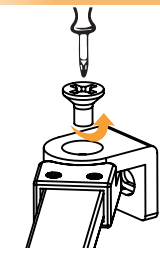

d

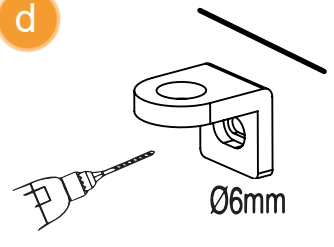

e

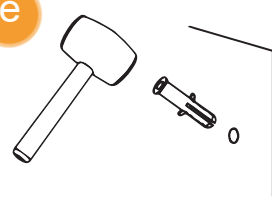

f

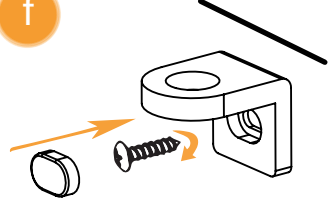

g

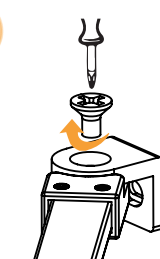

h

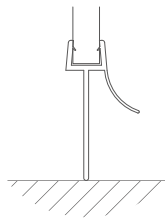
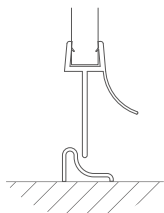
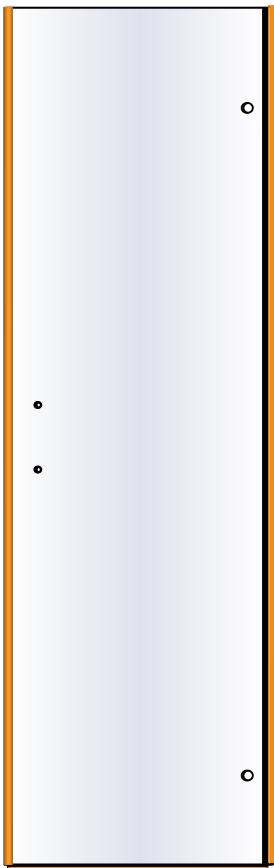
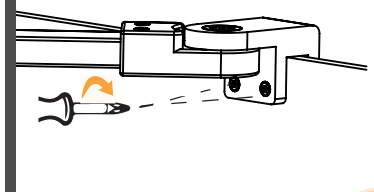

a

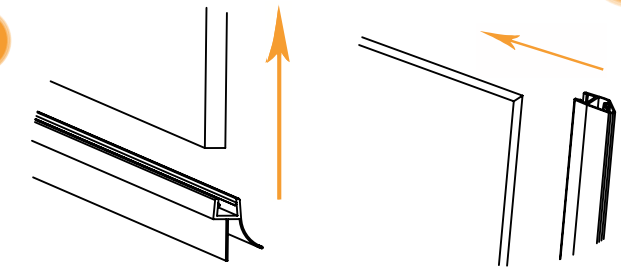

b

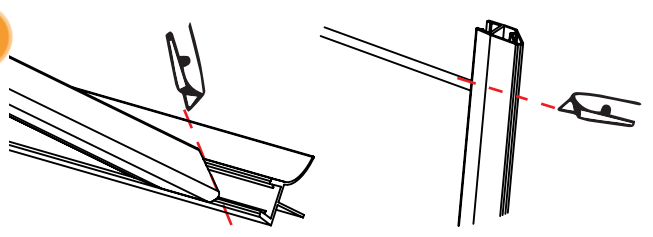

c

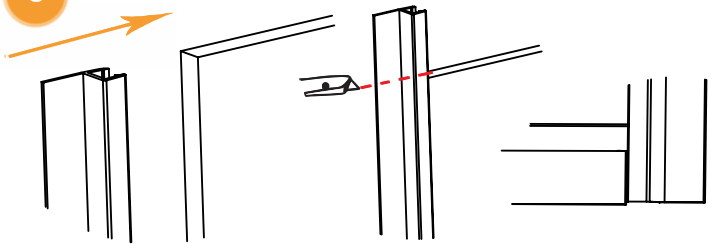

7

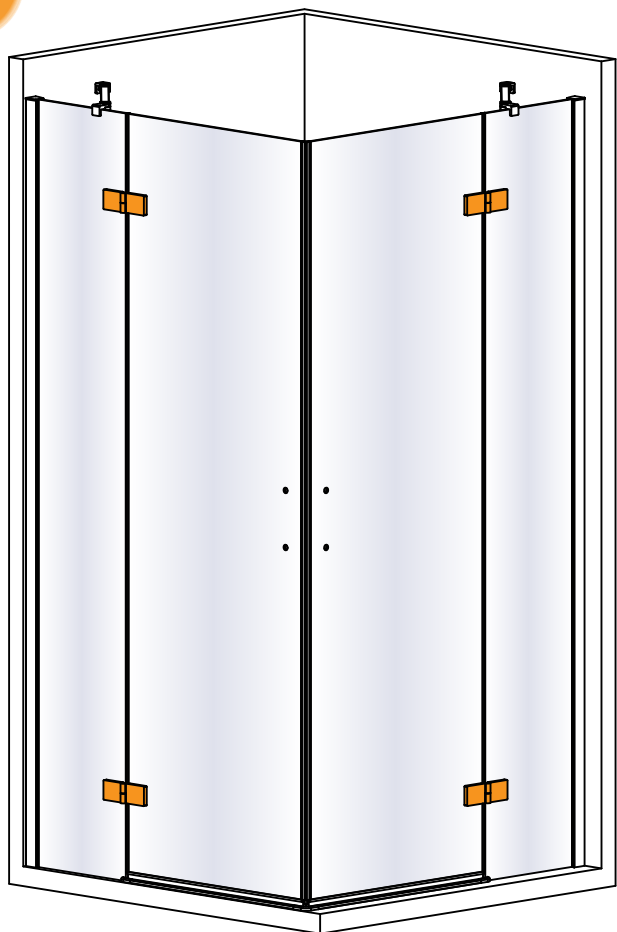

a

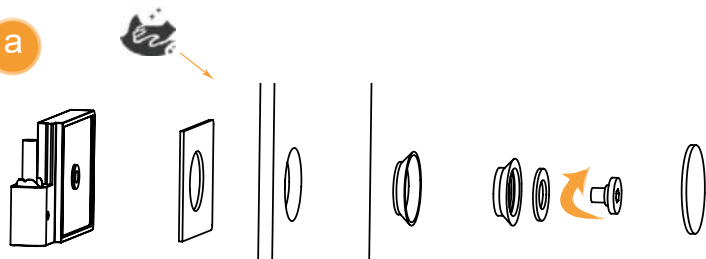

b

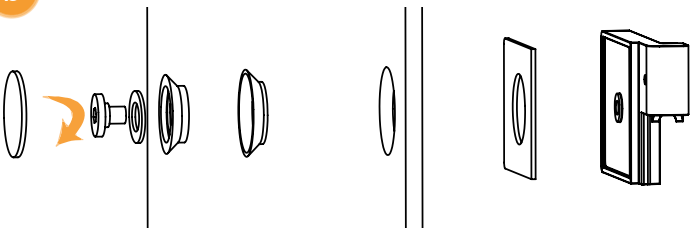

c

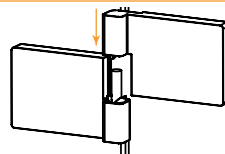

d

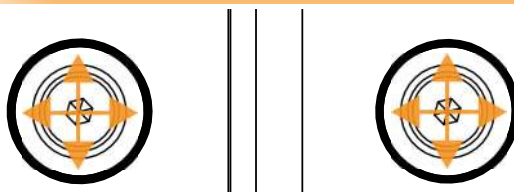

8

