

**I-0459**

v. 2



NEW  
TRENDY

NEW TRENDY Sp. z o.o.

Taszarowo 18 90

62-100 Wągrowiec

serwis@newtrendy.pl

tel/fax 67 262 12 66

SUPERIA

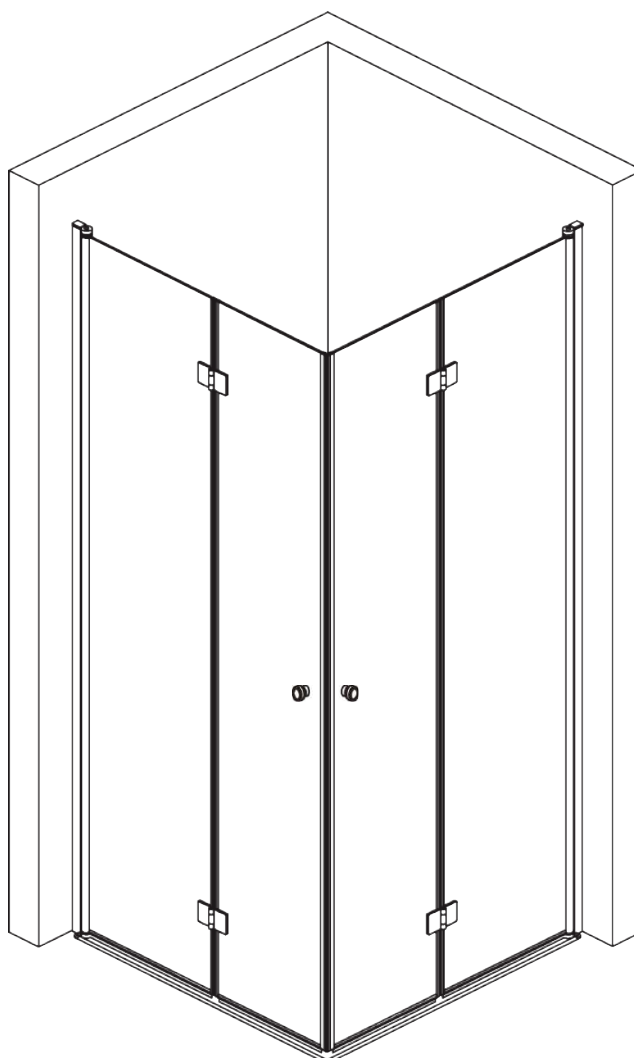

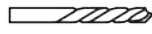
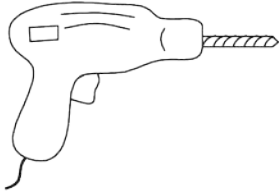
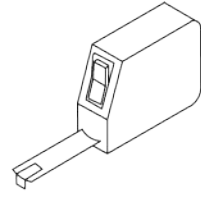
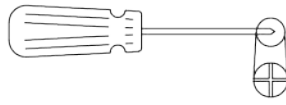
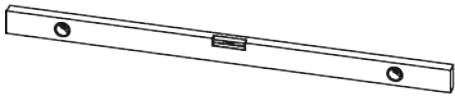



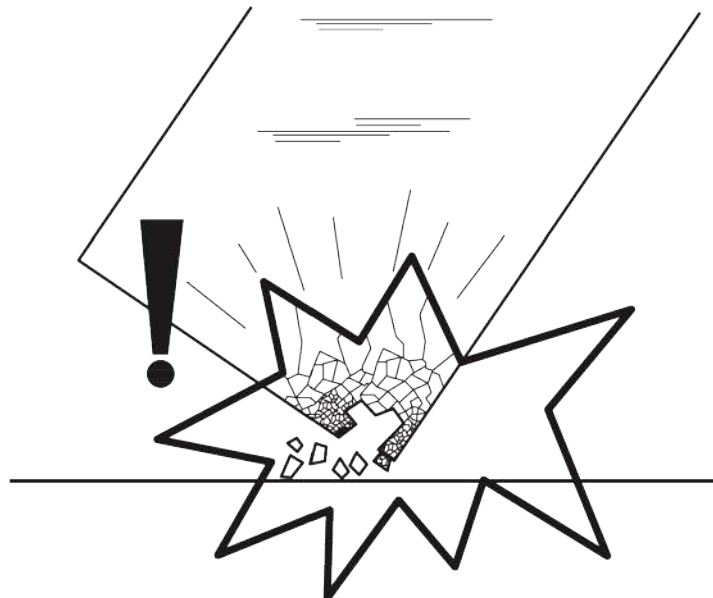
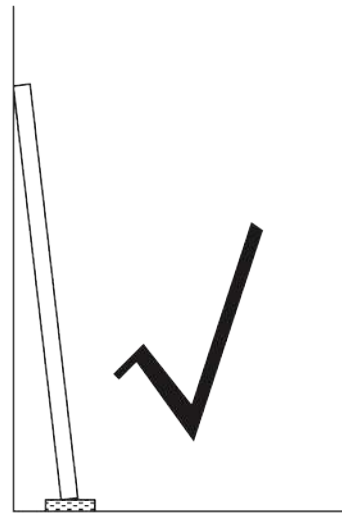
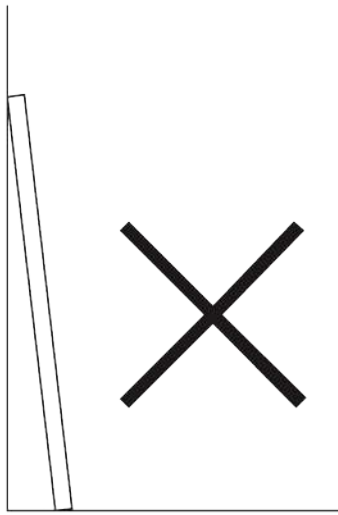
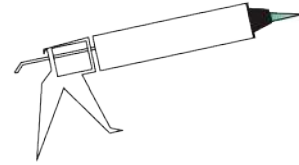

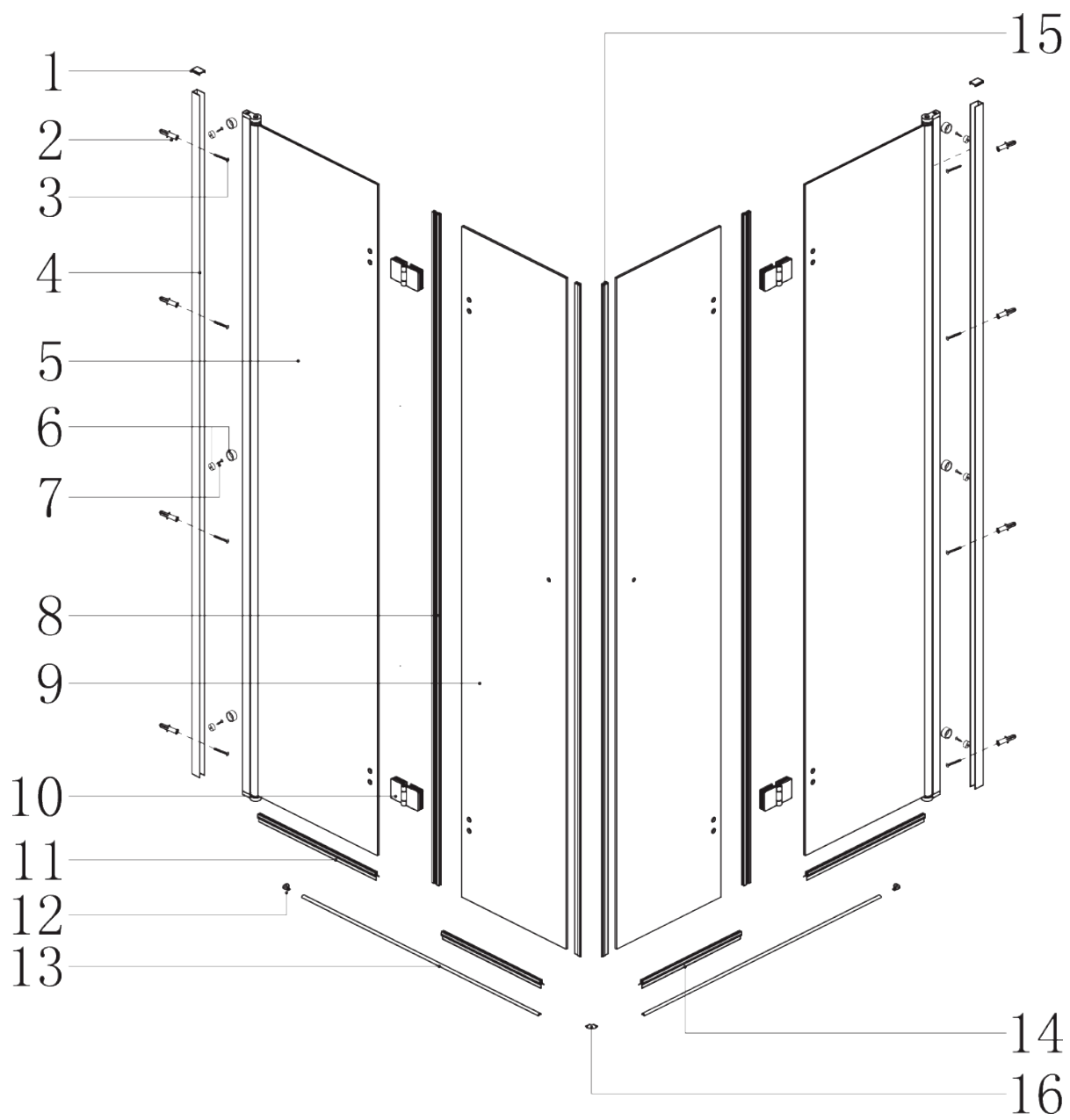









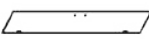



$\phi 6$   $\phi 2.8$





serial number	graphical	name	quantity	remarks
1			2 PCS	
2			8 PCS	
3		ST3. 9X35	8 PCS	
4			2 PCS	
5			2 PCS	
6			6 PCS	
7		ST3. 5X9. 5	6 PCS	
8			2 PCS	
9			2 PCS	
10			4 PCS	
11		L	2 PCS	
12		L/R	2 PCS	
13			2 PCS	
14		S	2 PCS	
15			2 PCS	
16			1 PCS	
17		M4	1 PCS	
18			1 PCS	

Wymiar	A	B
80x80	77,2 - 78,7	87,2 - 88,7
90x90	87,2 - 88,7	87,2 - 88,7
80x90	77,2 - 78,7	87,2 - 88,7
90x80	87,2 - 88,7	77,2 - 78,7

