

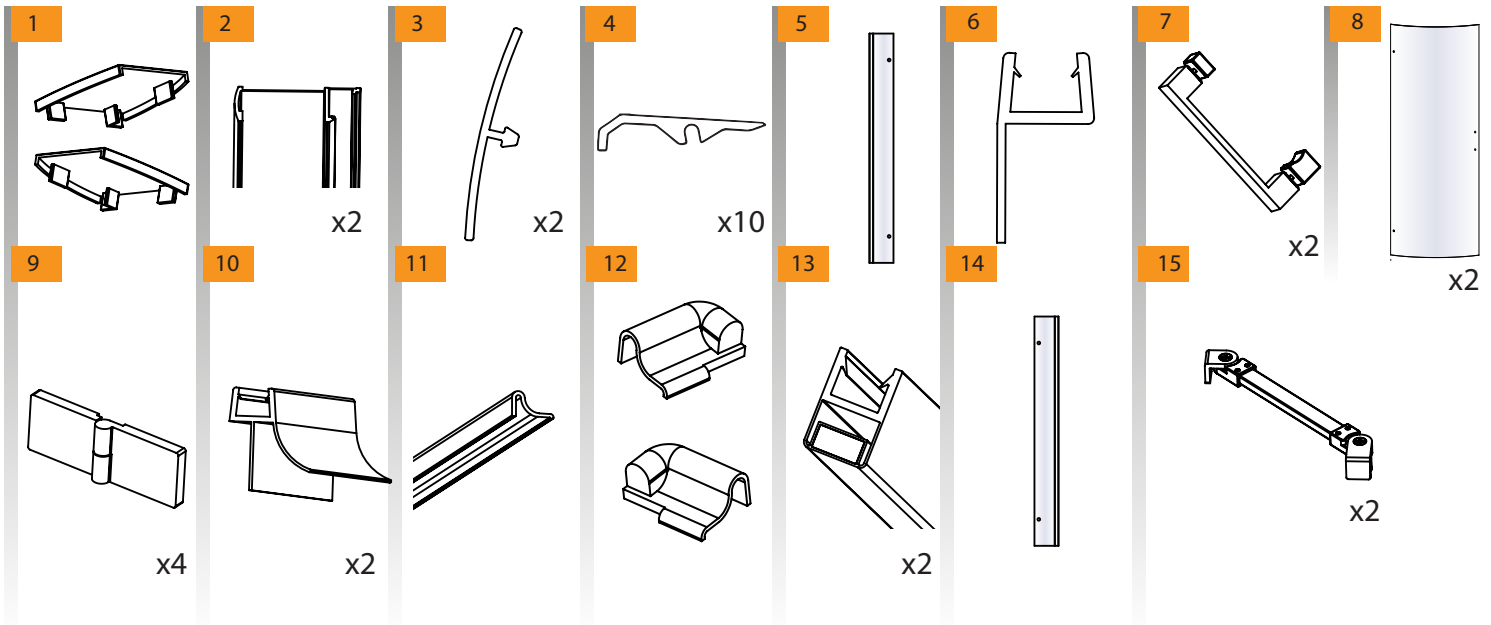

NEW MERANA

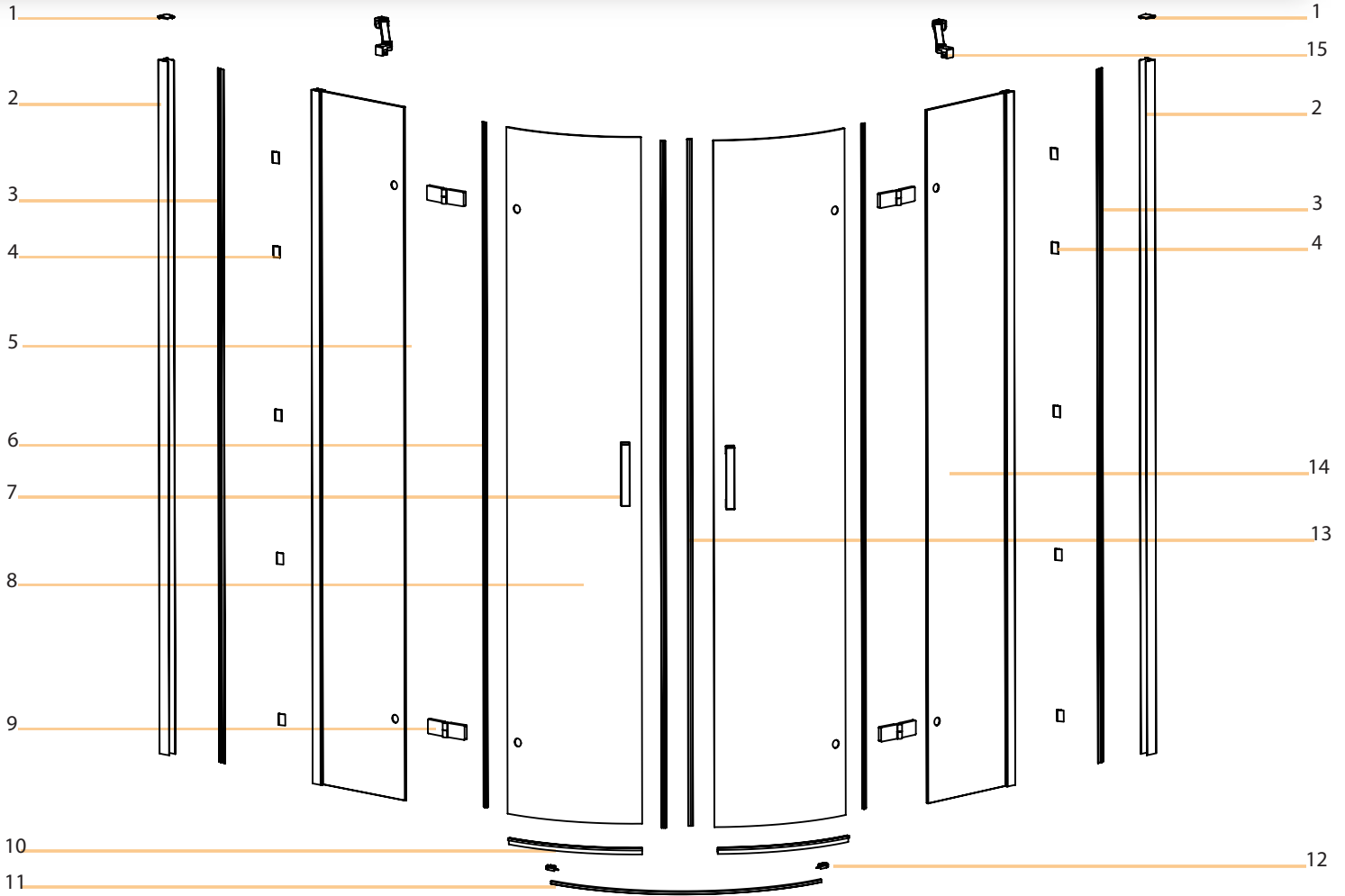

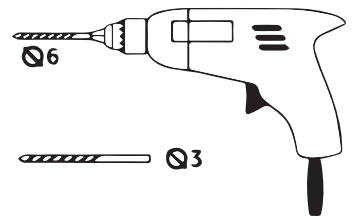
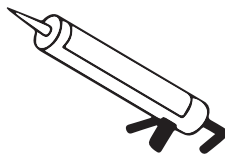
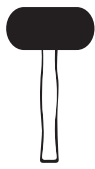
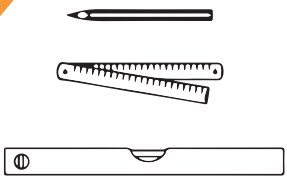

1

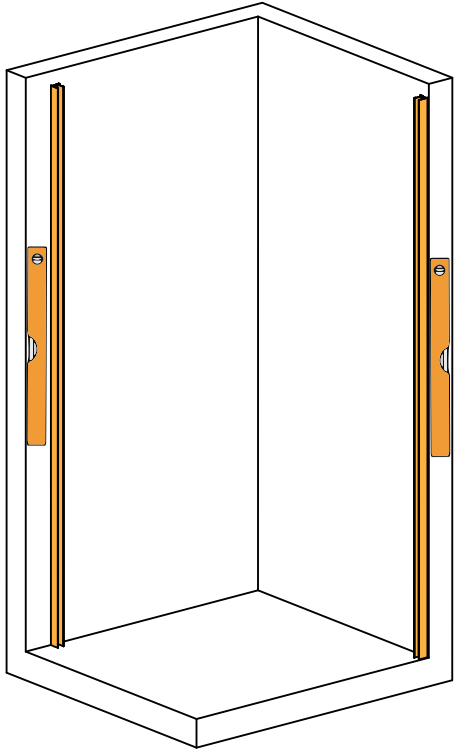

a

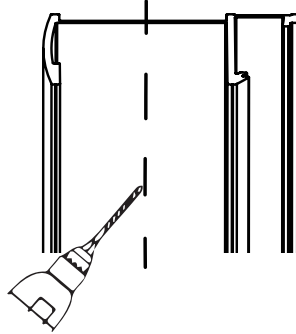

b

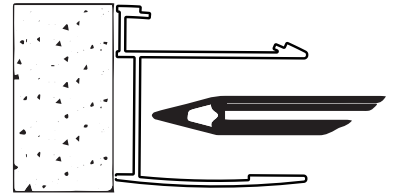

c

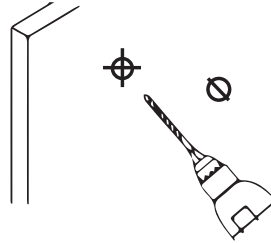

d

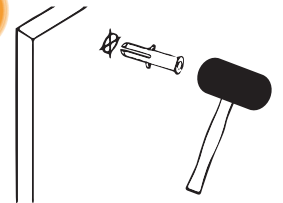

e

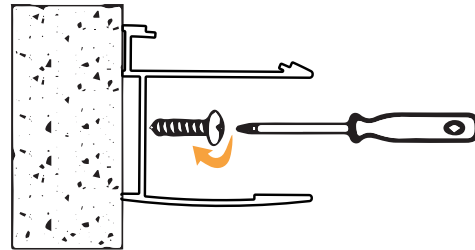

2

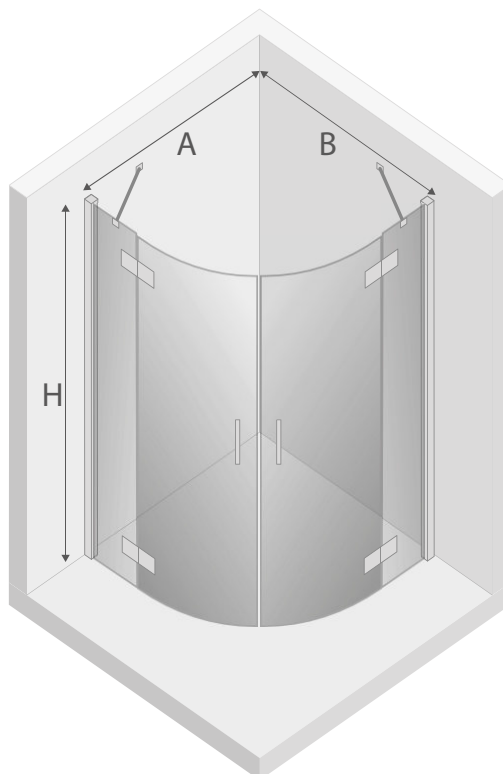



TABELA NIE DOTYCZY KABIN NA WYMIAR!
THE TABLE DOES NOT INCLUDE CUSTOM-MADE ENCLOSURES!

Specyfikacja techniczna **Kabin Na Wymiar** znajduje się w potwierdzeniu zamówienia.
The technical specification of the **Custom-Made Cabin** can be found in the order confirmation.

	Wymiary gabarytowe Overall dimensions		Wymiary do osi szyby Dimensions to the pane axis	
	A	B	X1	X2
80x80x195	78,5-80	78,5-80	77,2-78,7	77,2-78,7
90x90x195	88,5-90	88,5-90	87,2-88,7	87,2-88,7
100x100x195	98,5-100	98,5-100	97,2-98,7	97,2-98,7

3

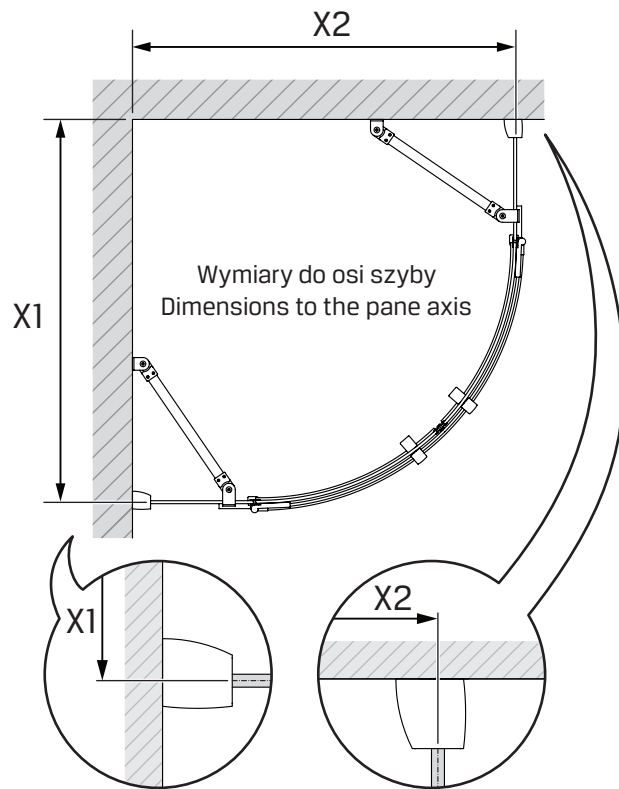
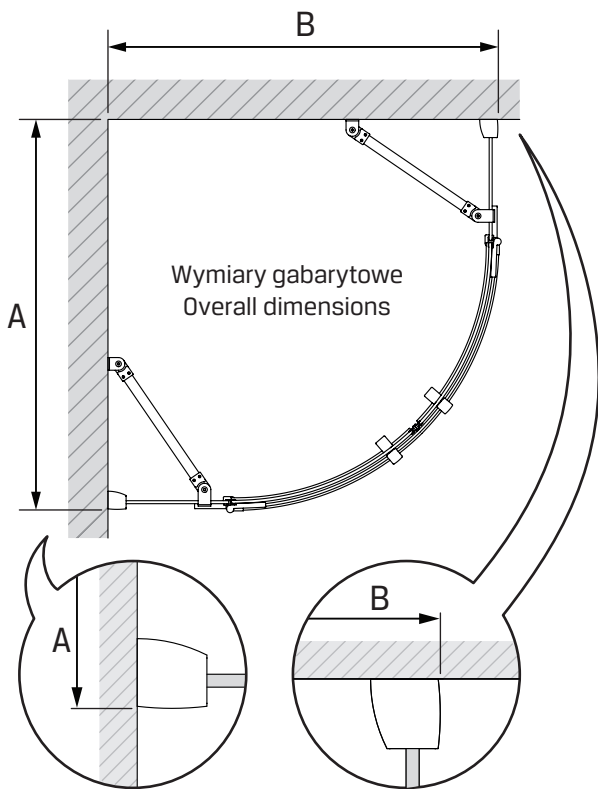
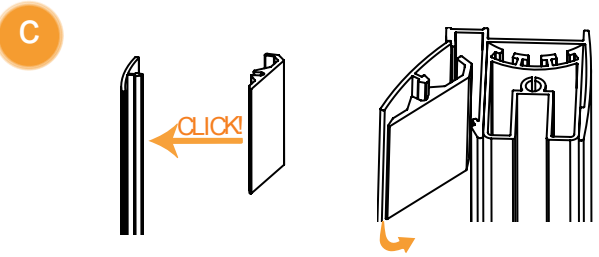
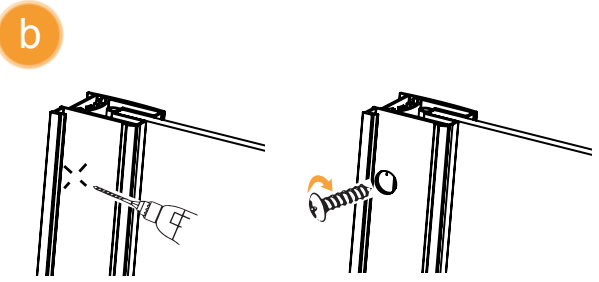
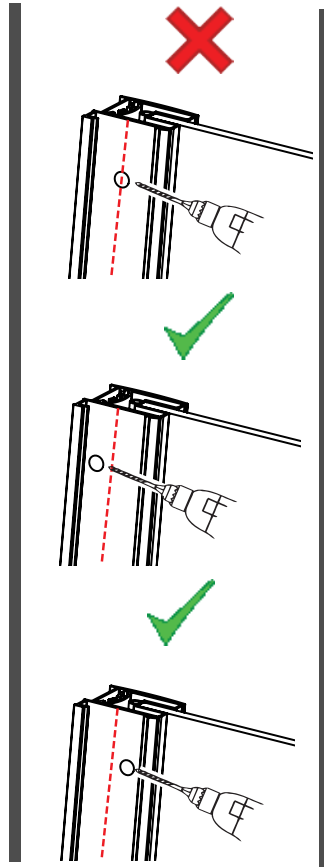
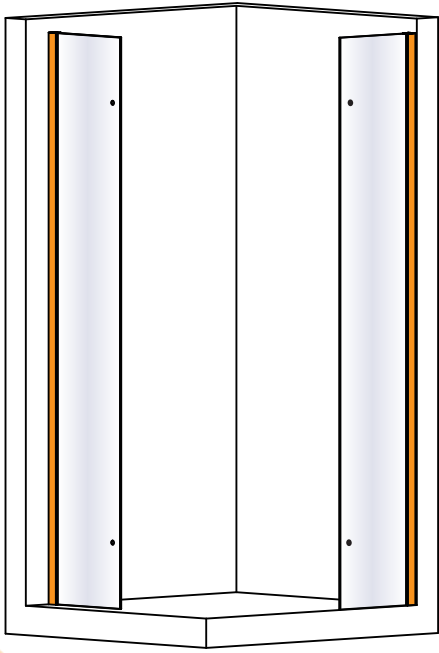

4

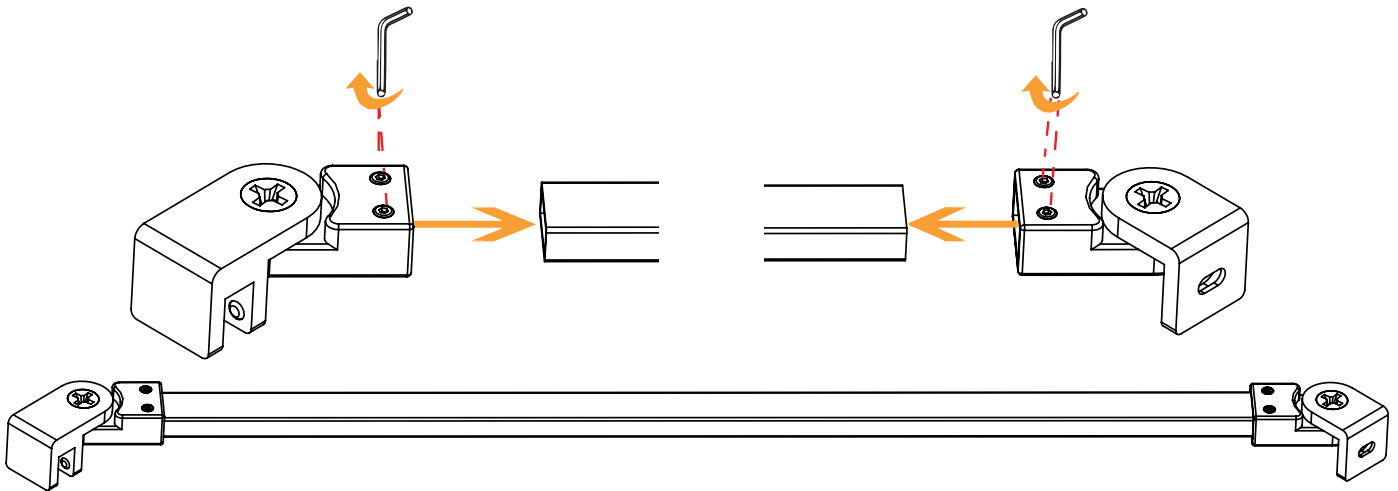
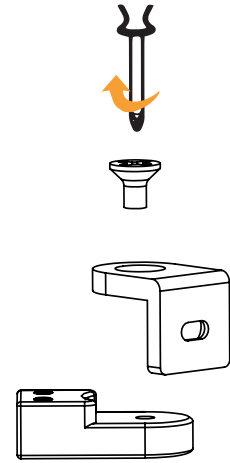
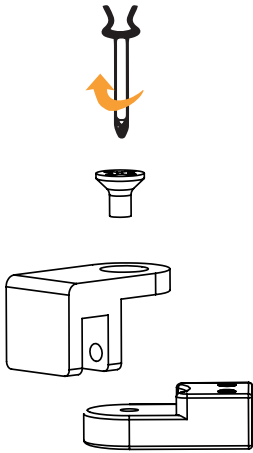

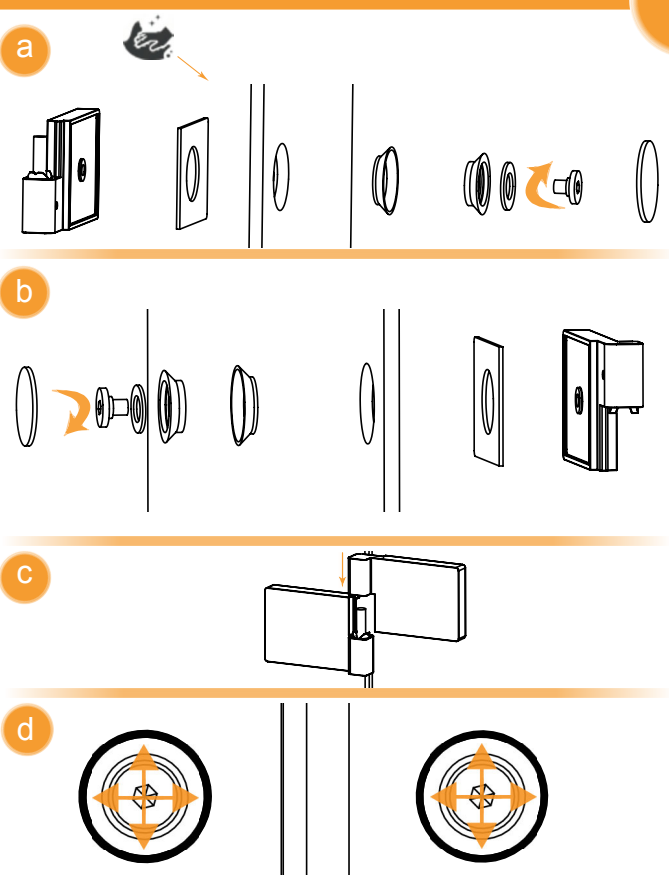
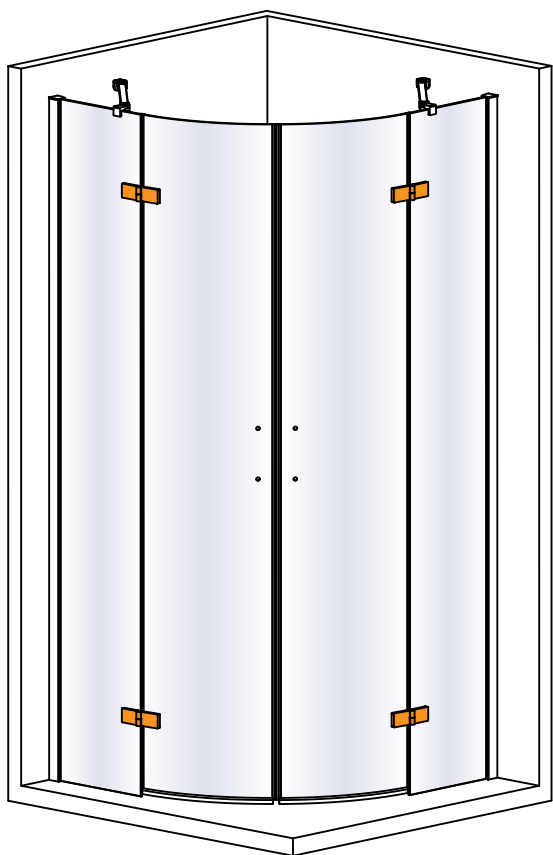
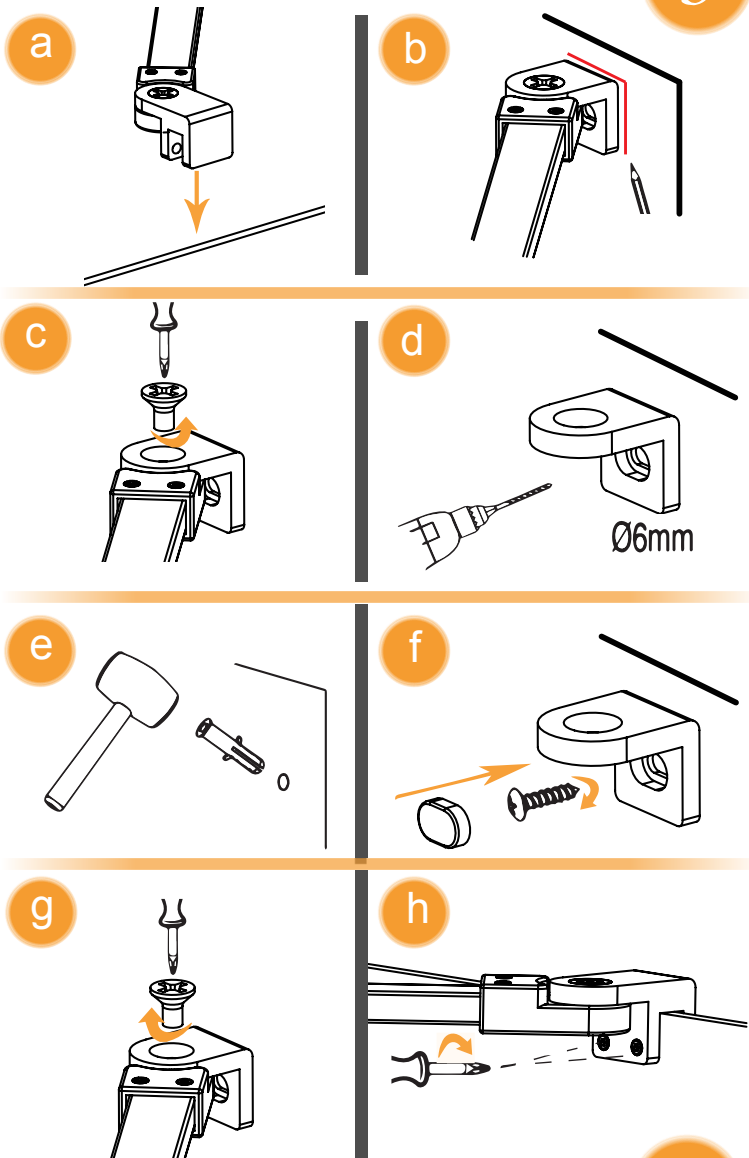
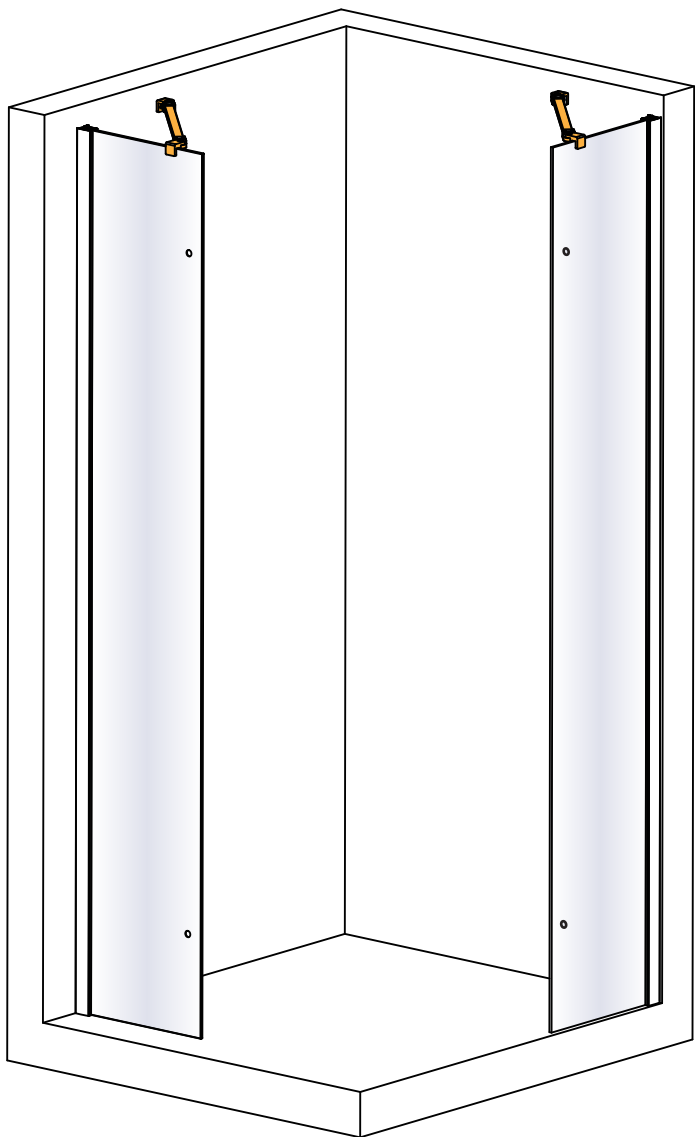

7

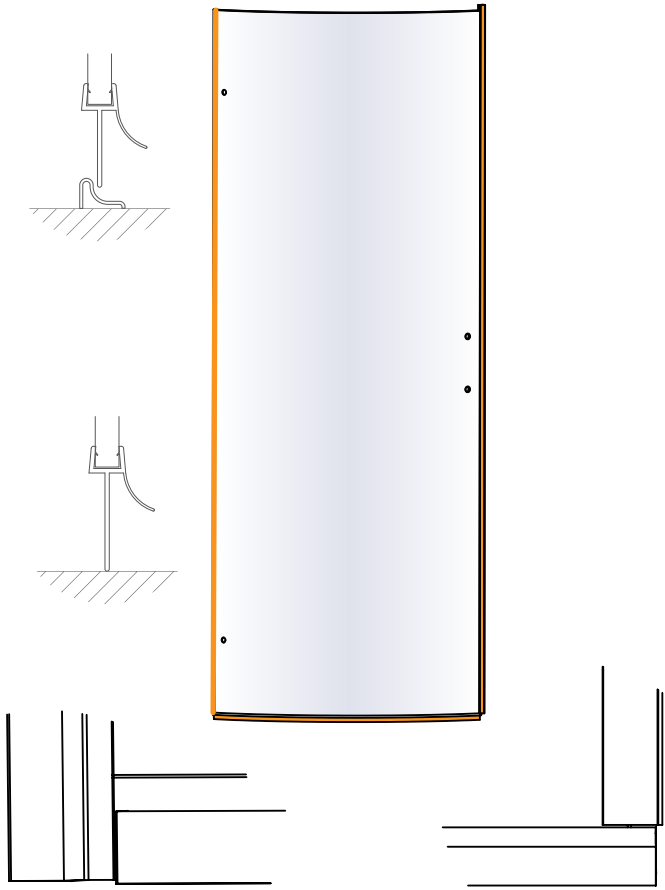

a

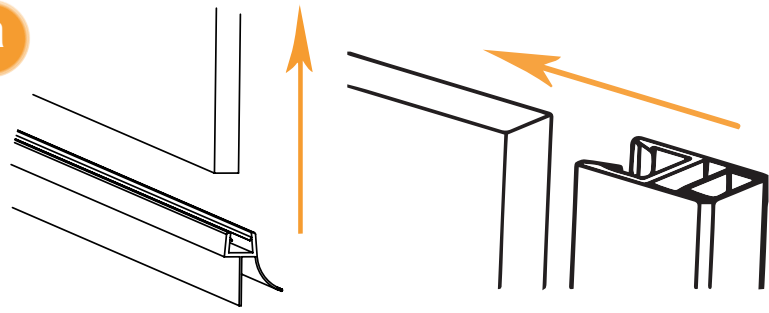

b

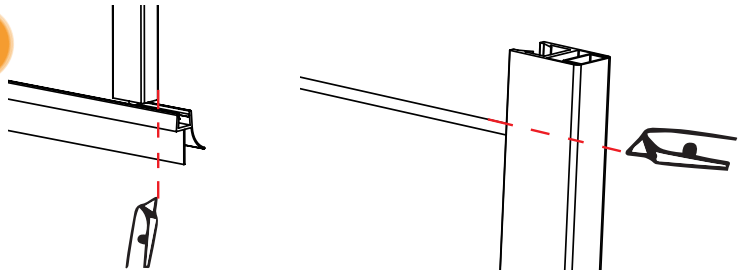

c

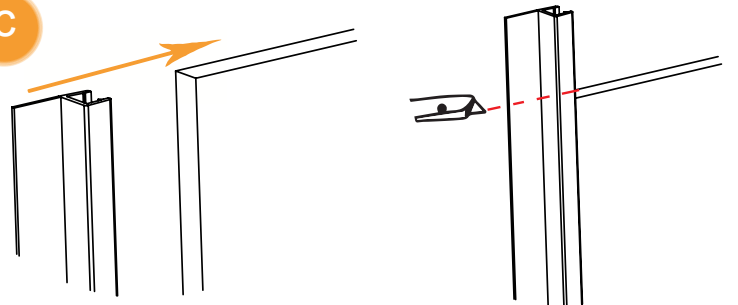

8

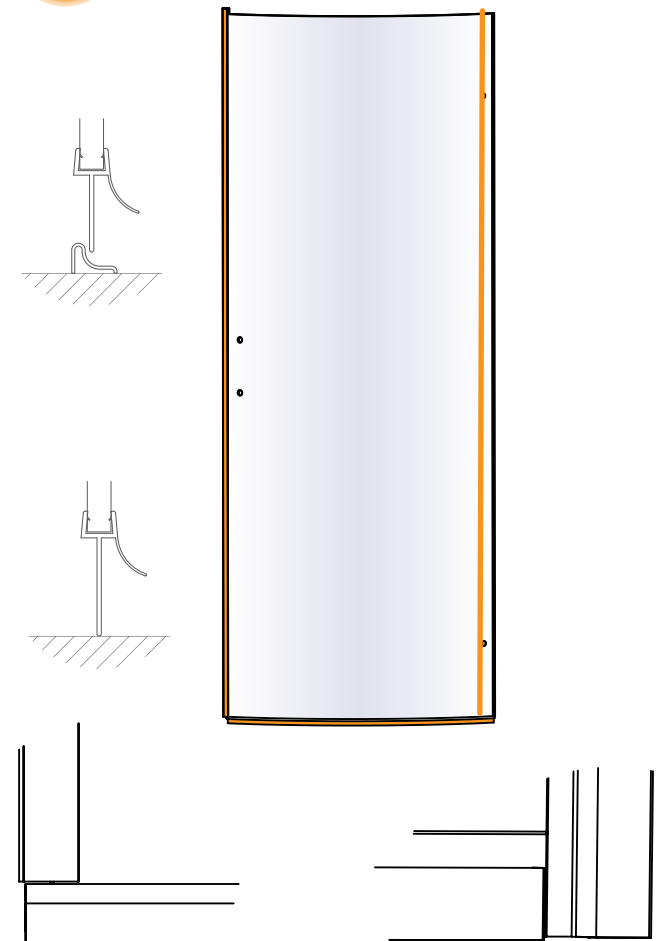

a

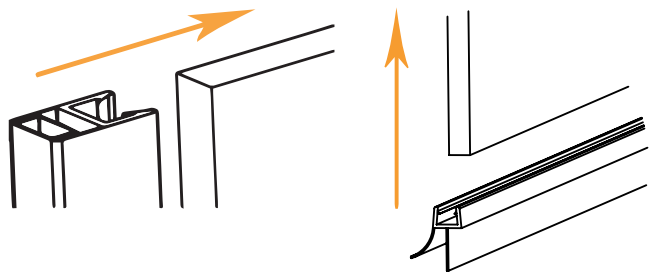

b

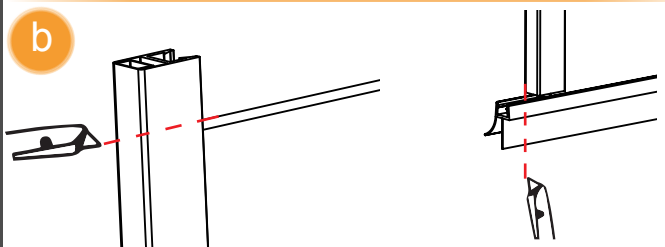

c

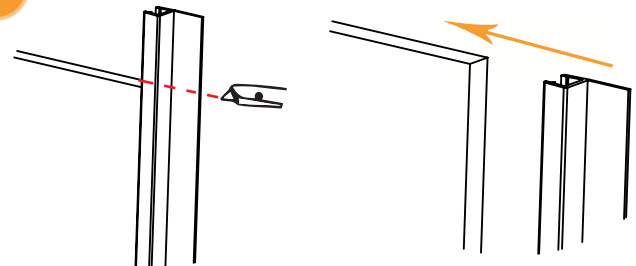

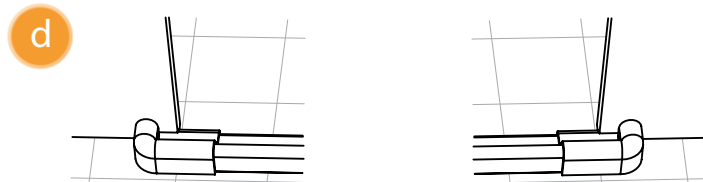
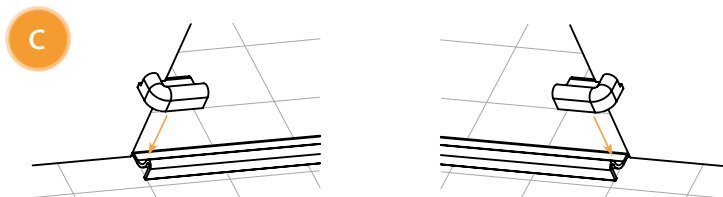
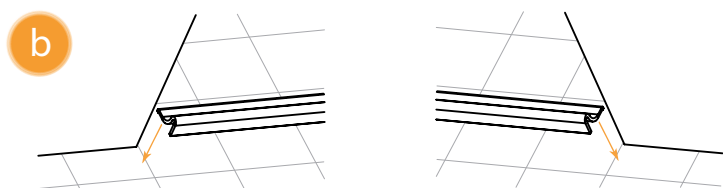
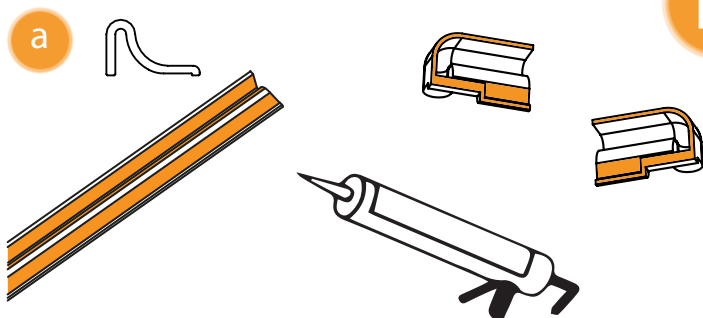
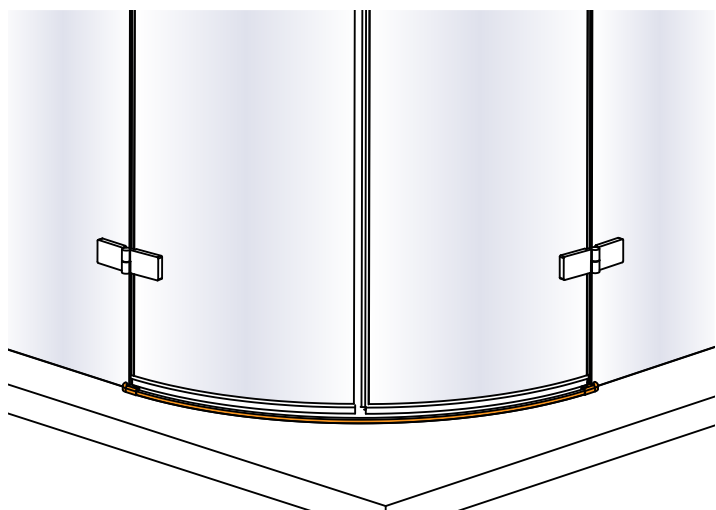
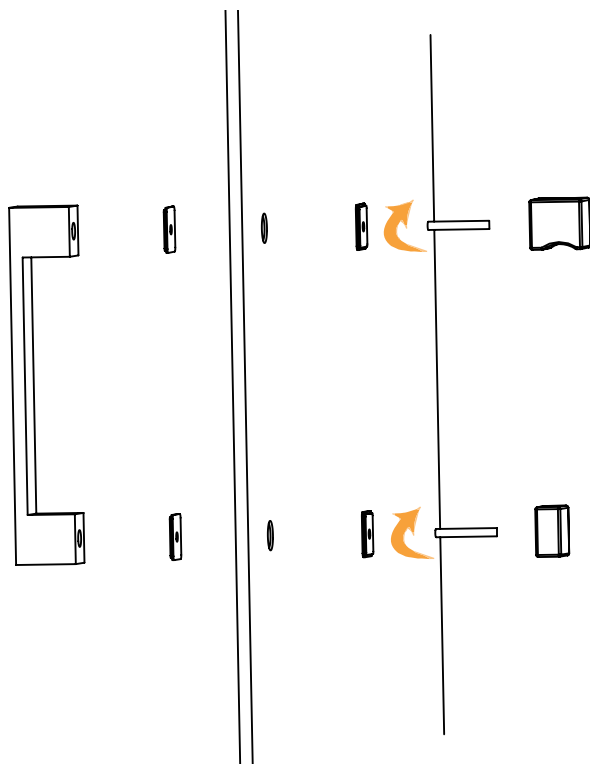
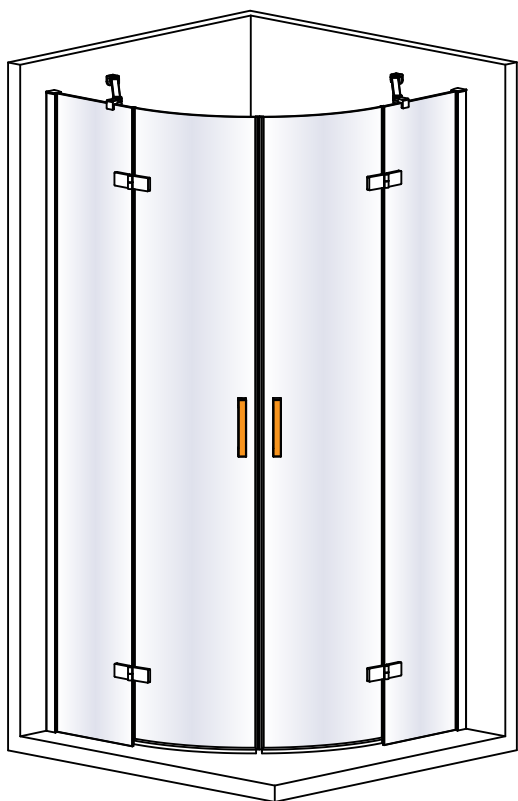

11

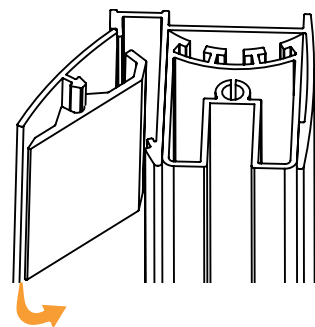
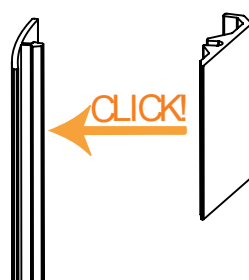
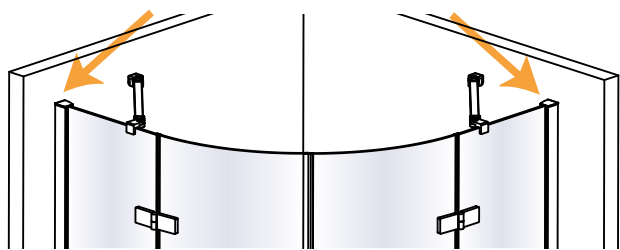

12

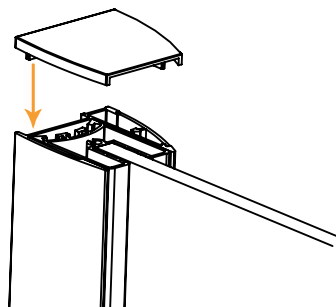

24H

