

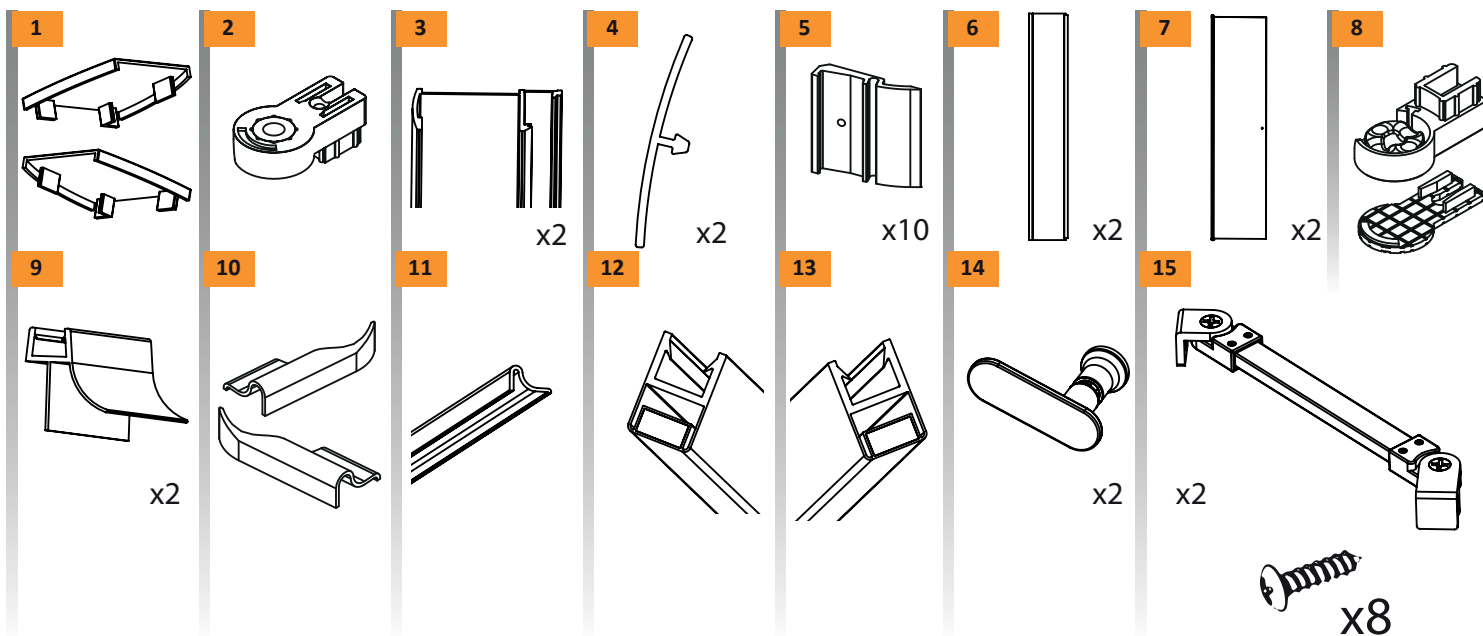

NEW SOLEO

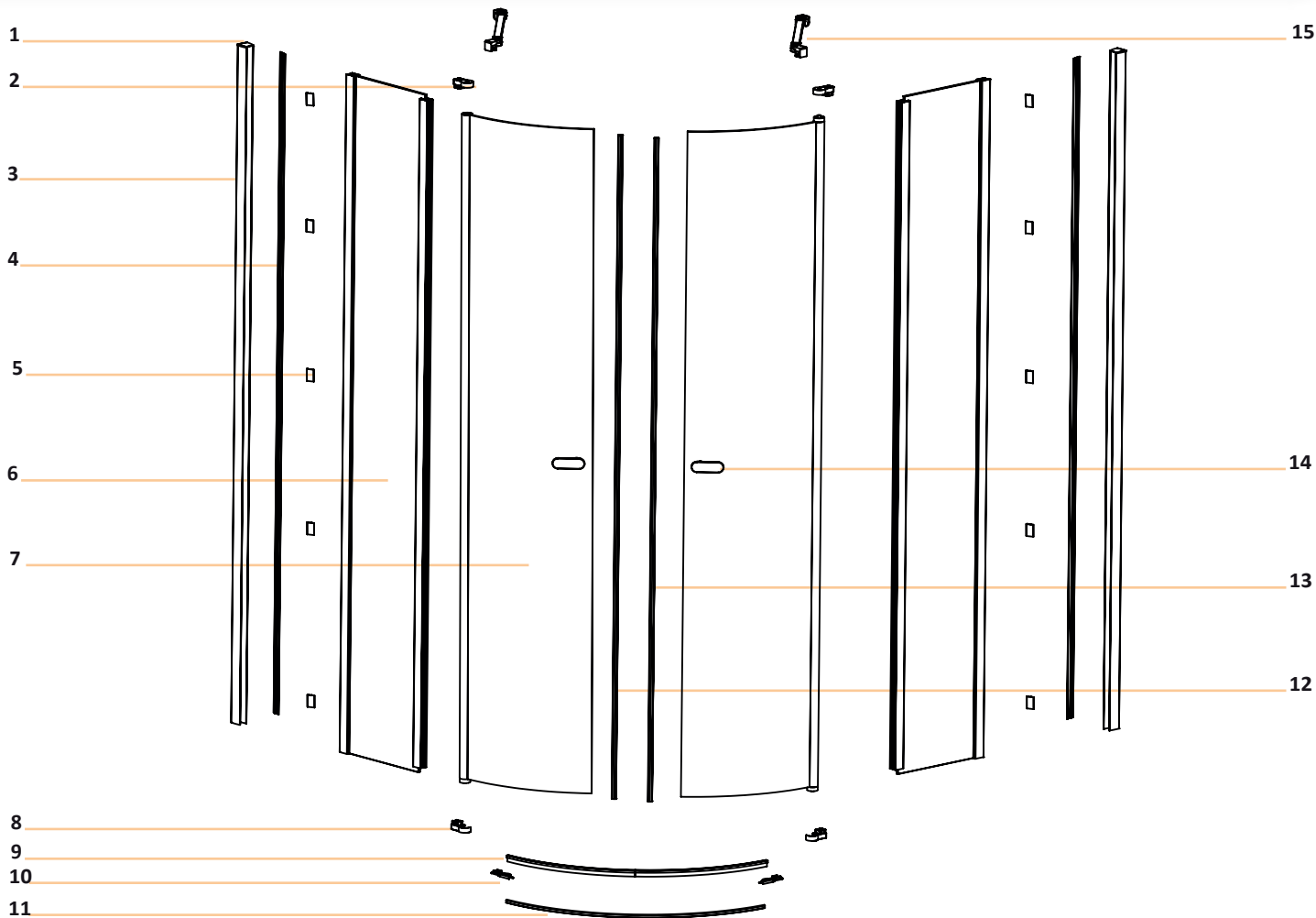

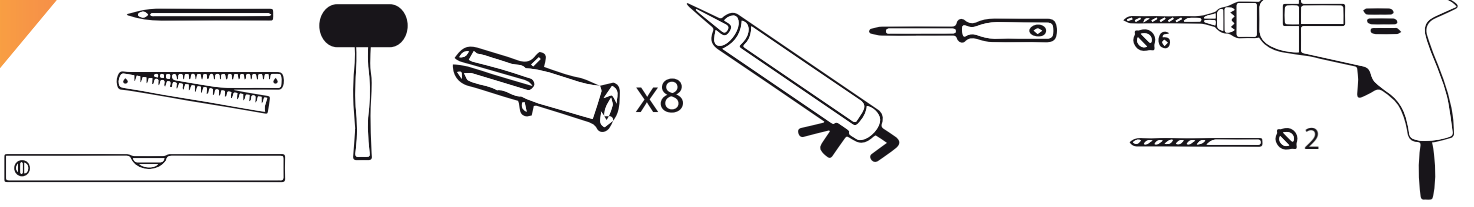

1

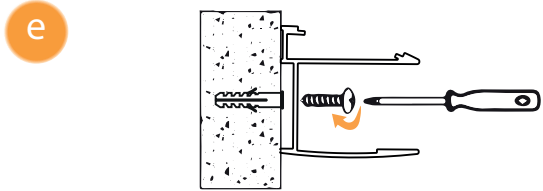
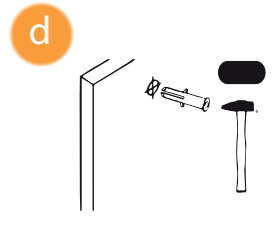
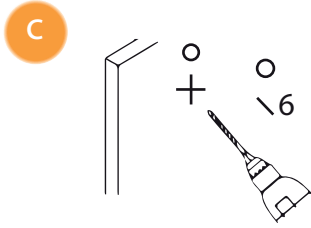
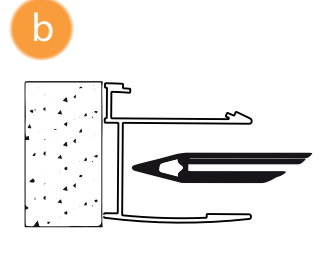
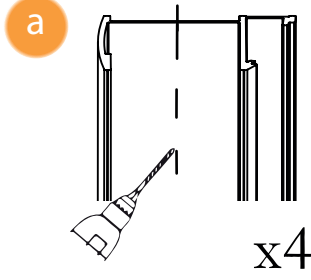
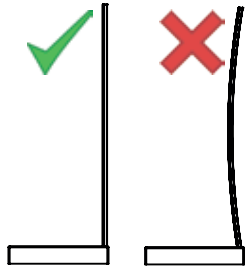
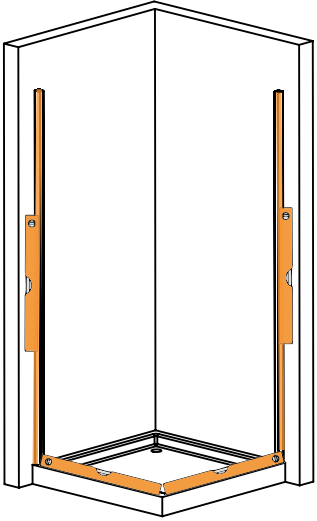
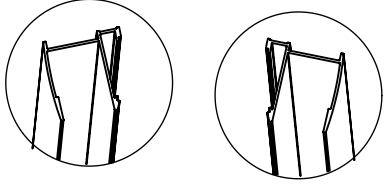

2

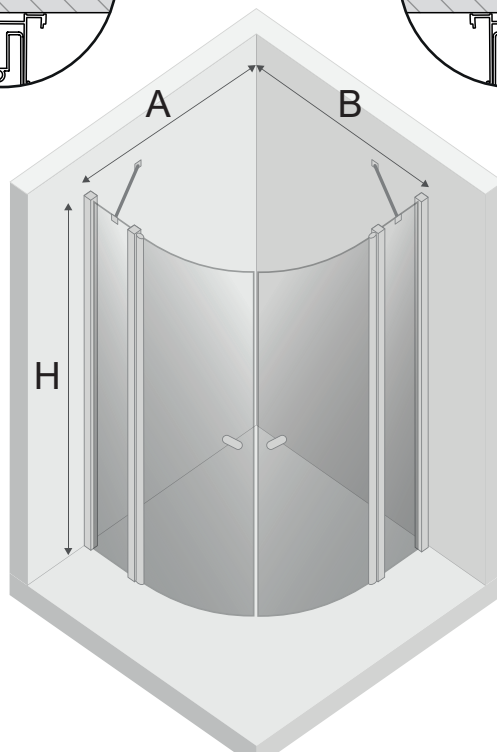
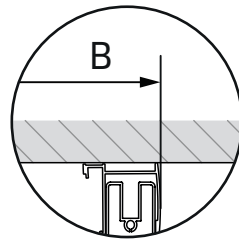
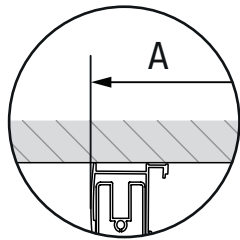

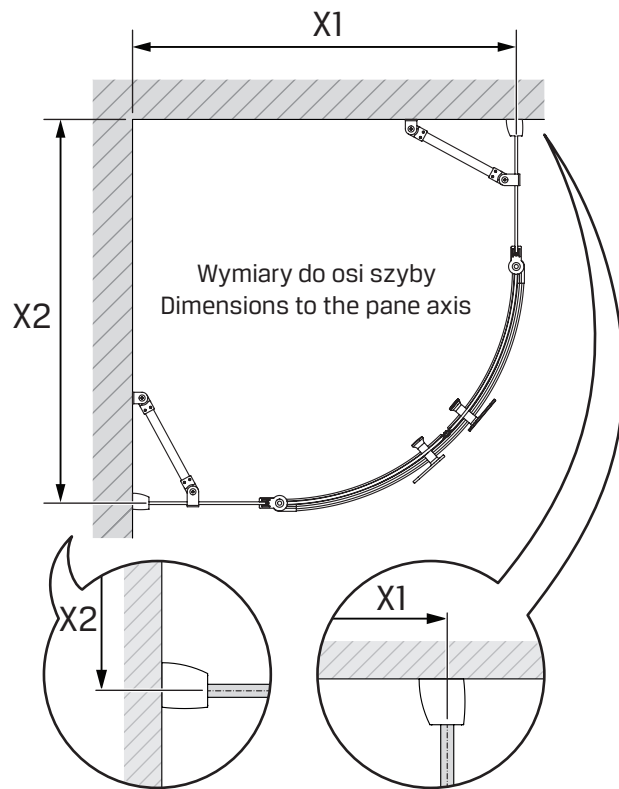
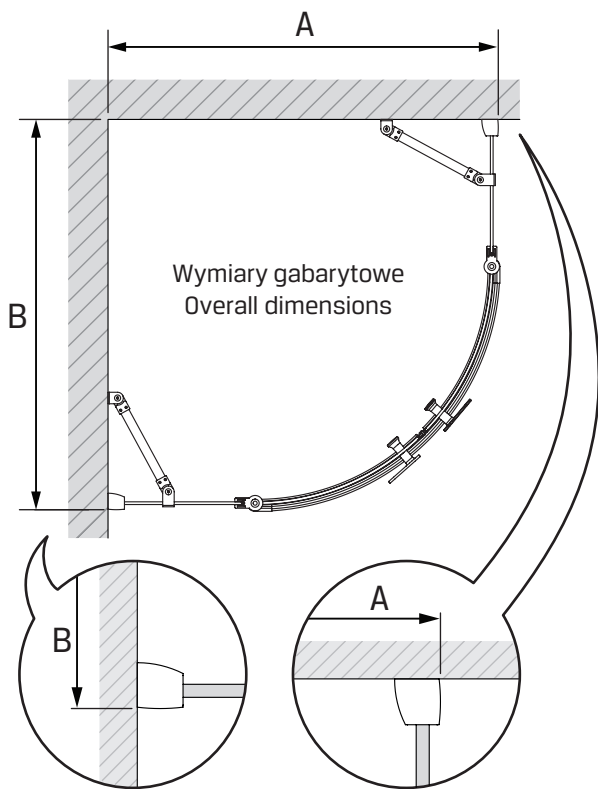

**TABELA NIE DOTYCZY KABIN NA WYMIAR!
THE TABLE DOES NOT INCLUDE CUSTOM-MADE ENCLOSURES!**

Specyfikacja techniczna **Kabin Na Wymiar** znajduje się w potwierdzeniu zamówienia.
The technical specification of the **Custom-Made Cabin** can be found in the order confirmation.

	Wymiary gabarytowe Overall dimensions		Wymiary do osi szyby Dimensions to the pane axis	
	A	B	X1	X2
80x80x195	79-80,2	79-80,2	77,7-79,2	77,7-79,2
90x90x195	89-90,2	89-90,2	87,7-89,2	87,7-89,2
100x100x195	99-100,2	99-100,2	97,7-99,2	97,7-99,2

3

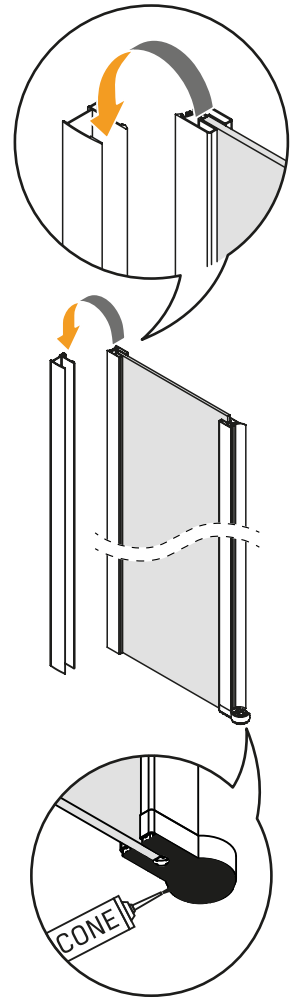
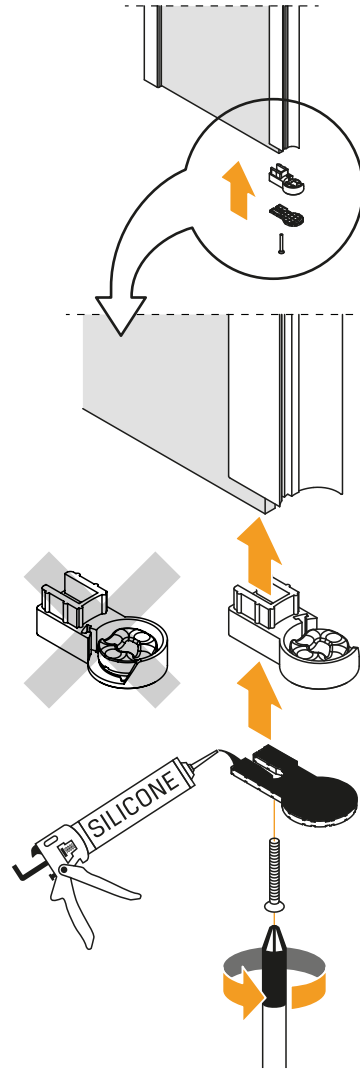
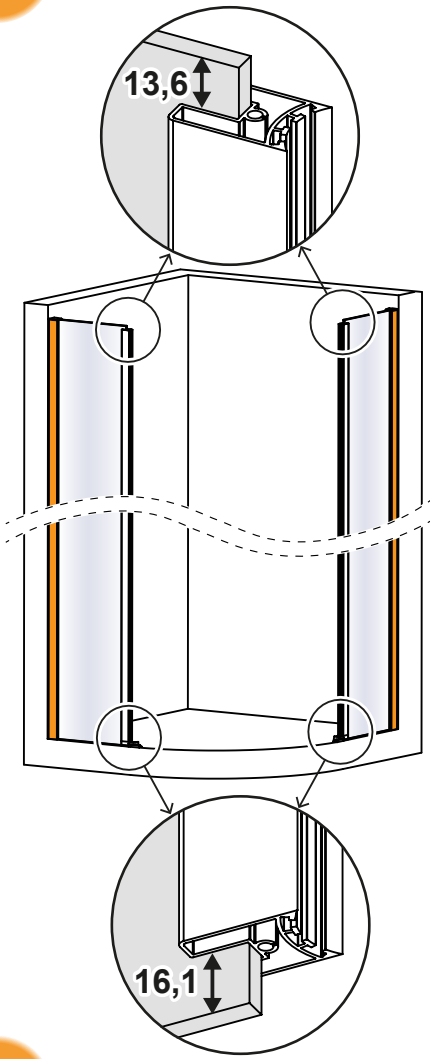

4

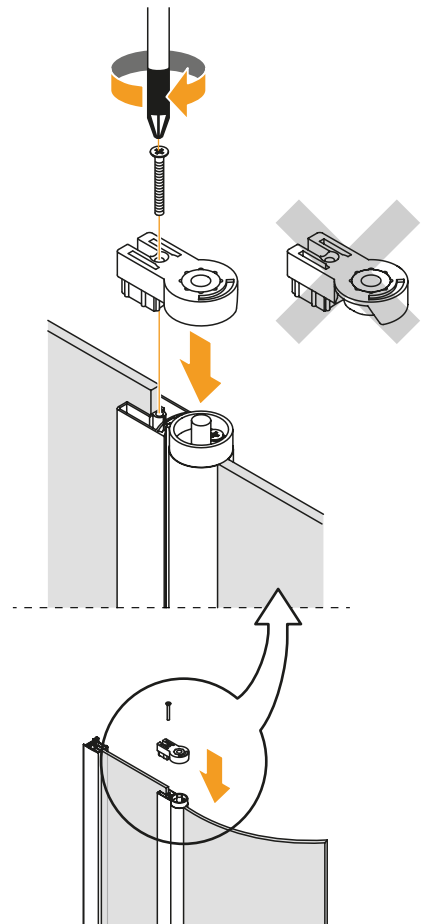
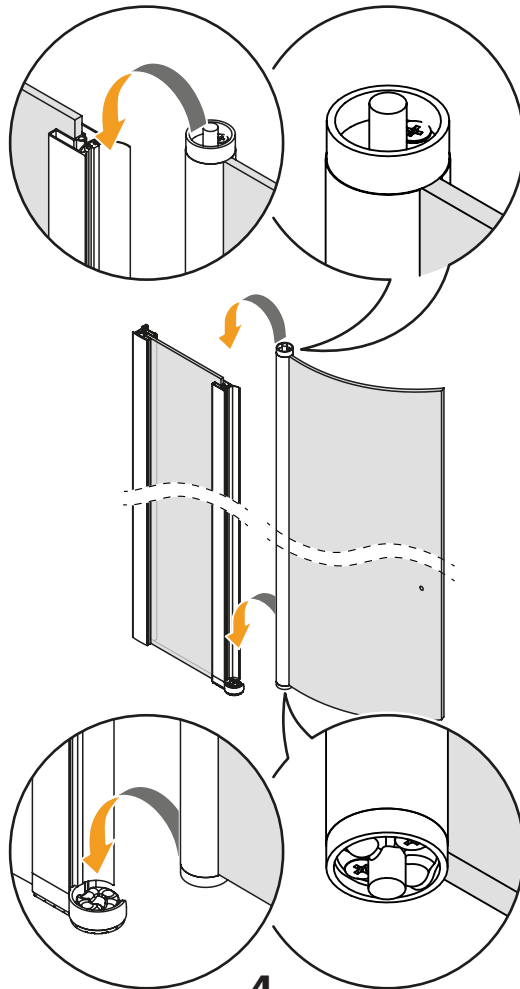
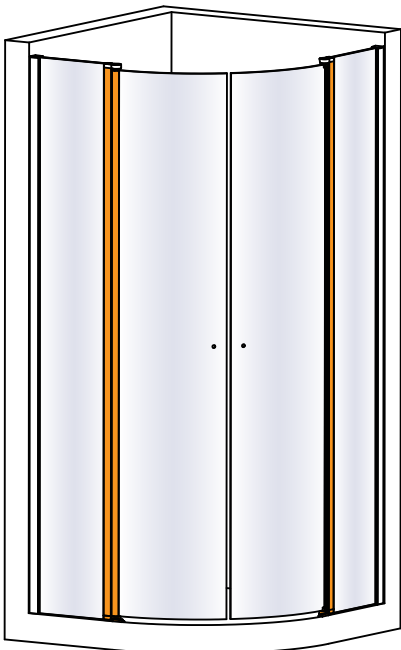

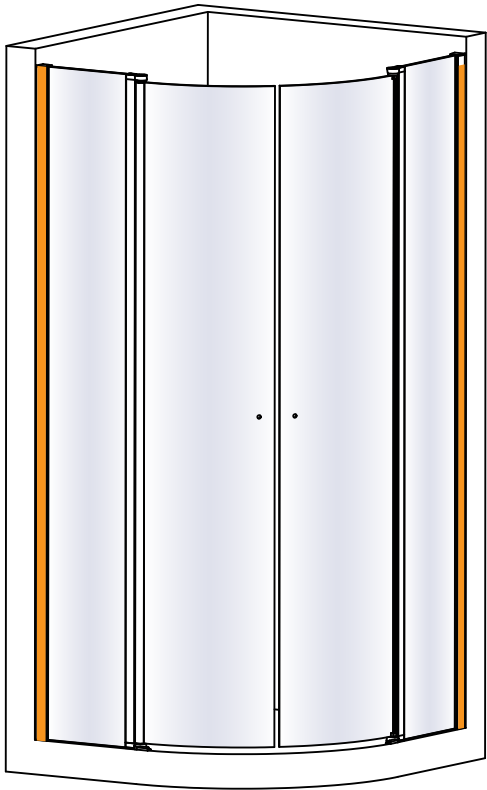

a

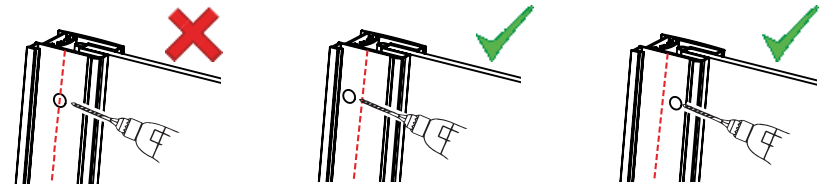
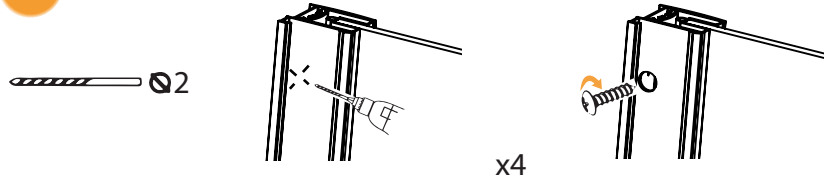

b

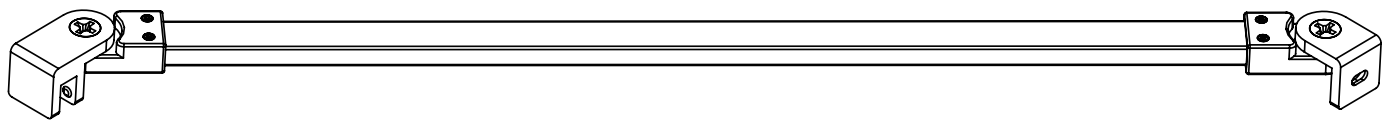
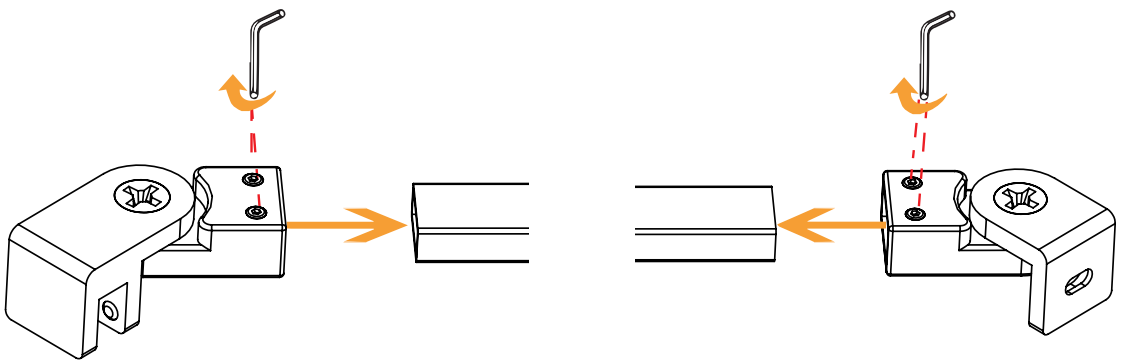
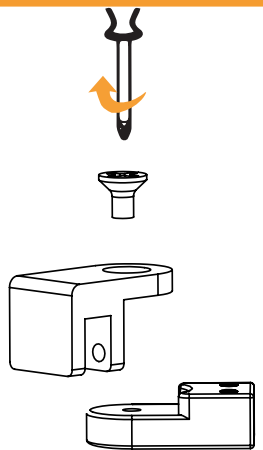
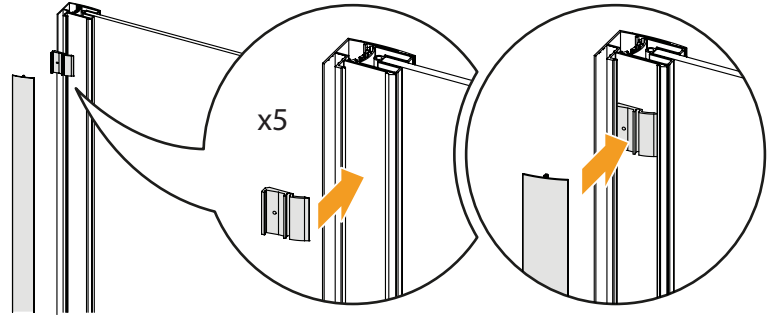

7

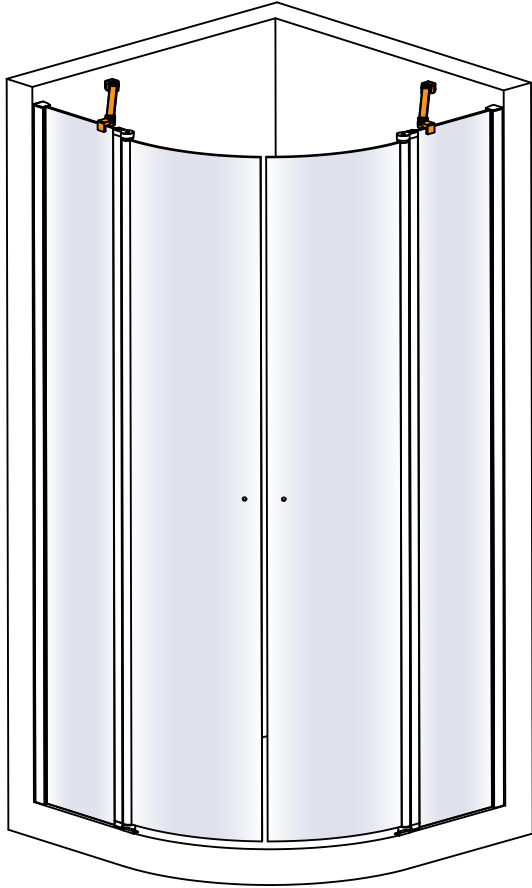
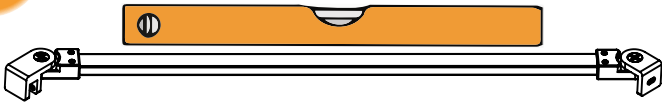

a

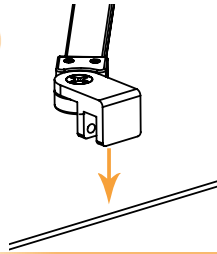

b

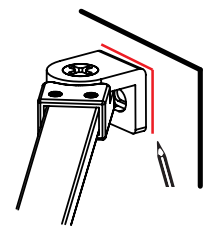

c



d

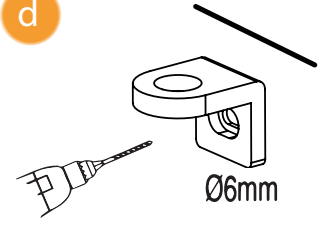

e

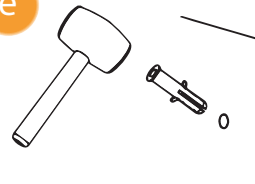

f

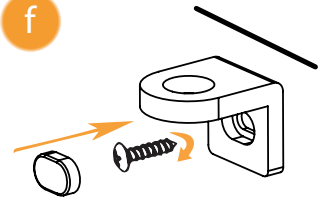

g

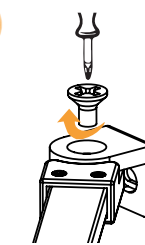

h

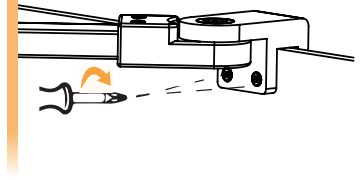

8

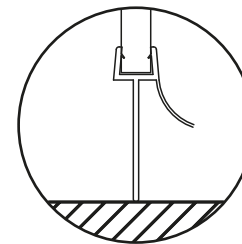
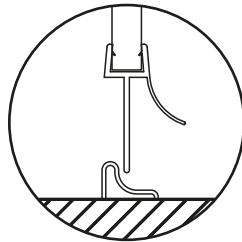
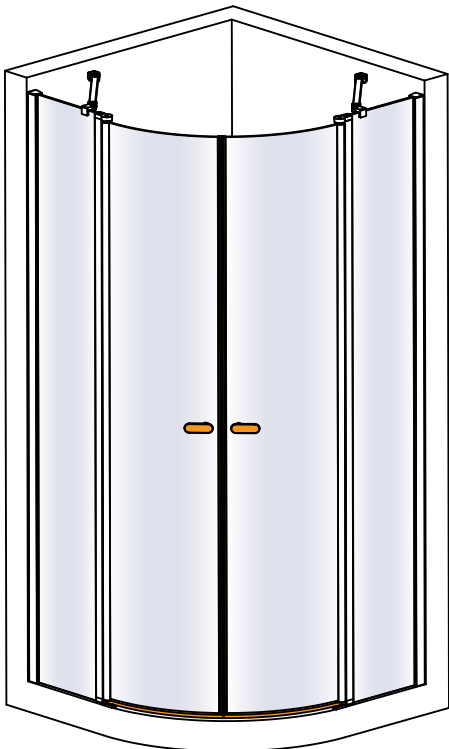

a

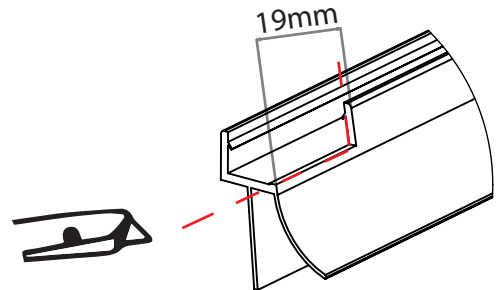

b

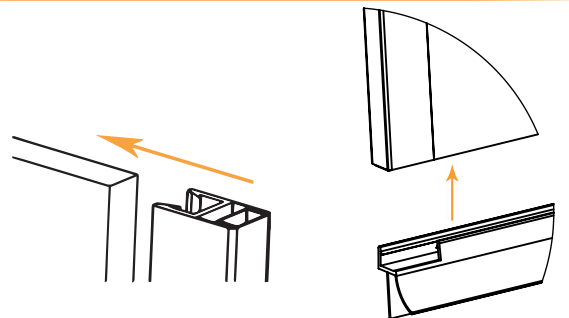

c

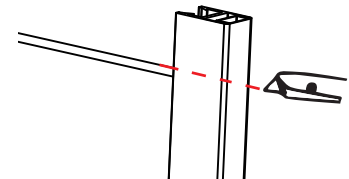

d



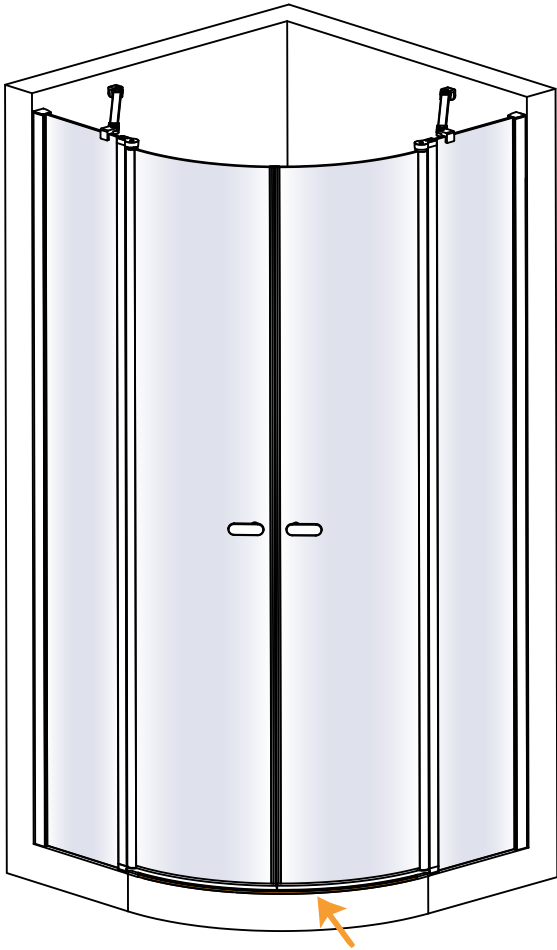

a

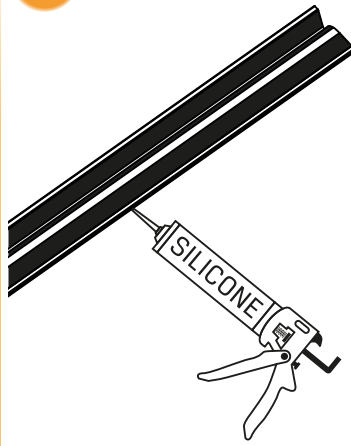

b

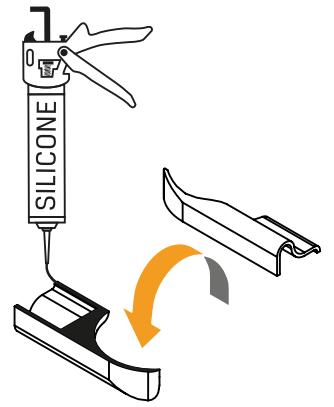

c

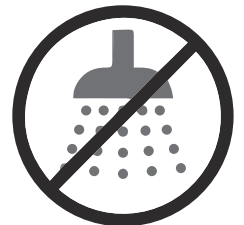
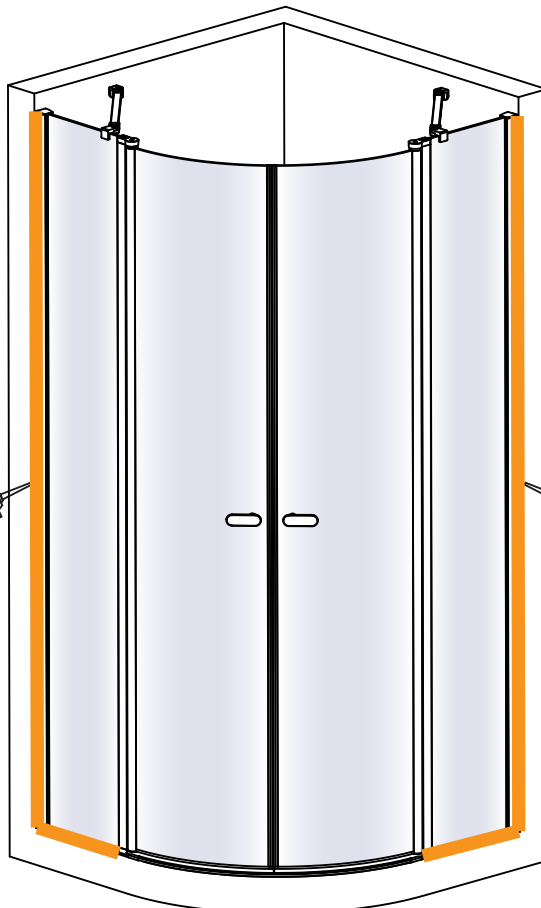
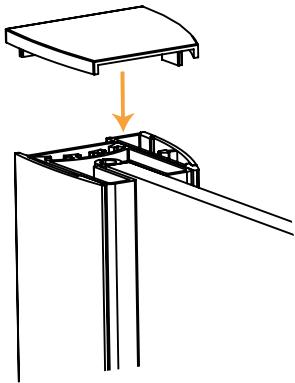
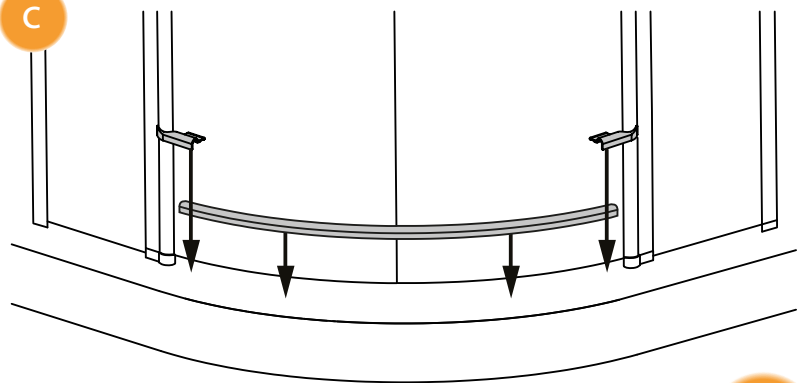

24H