

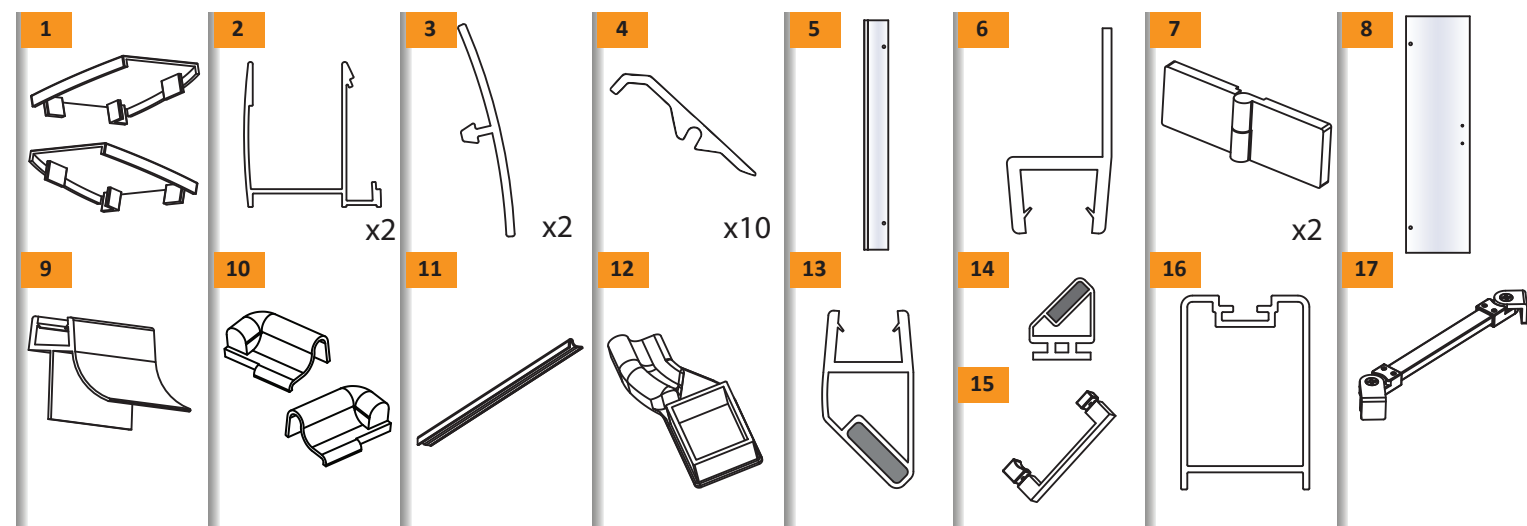

NEW RENOMA

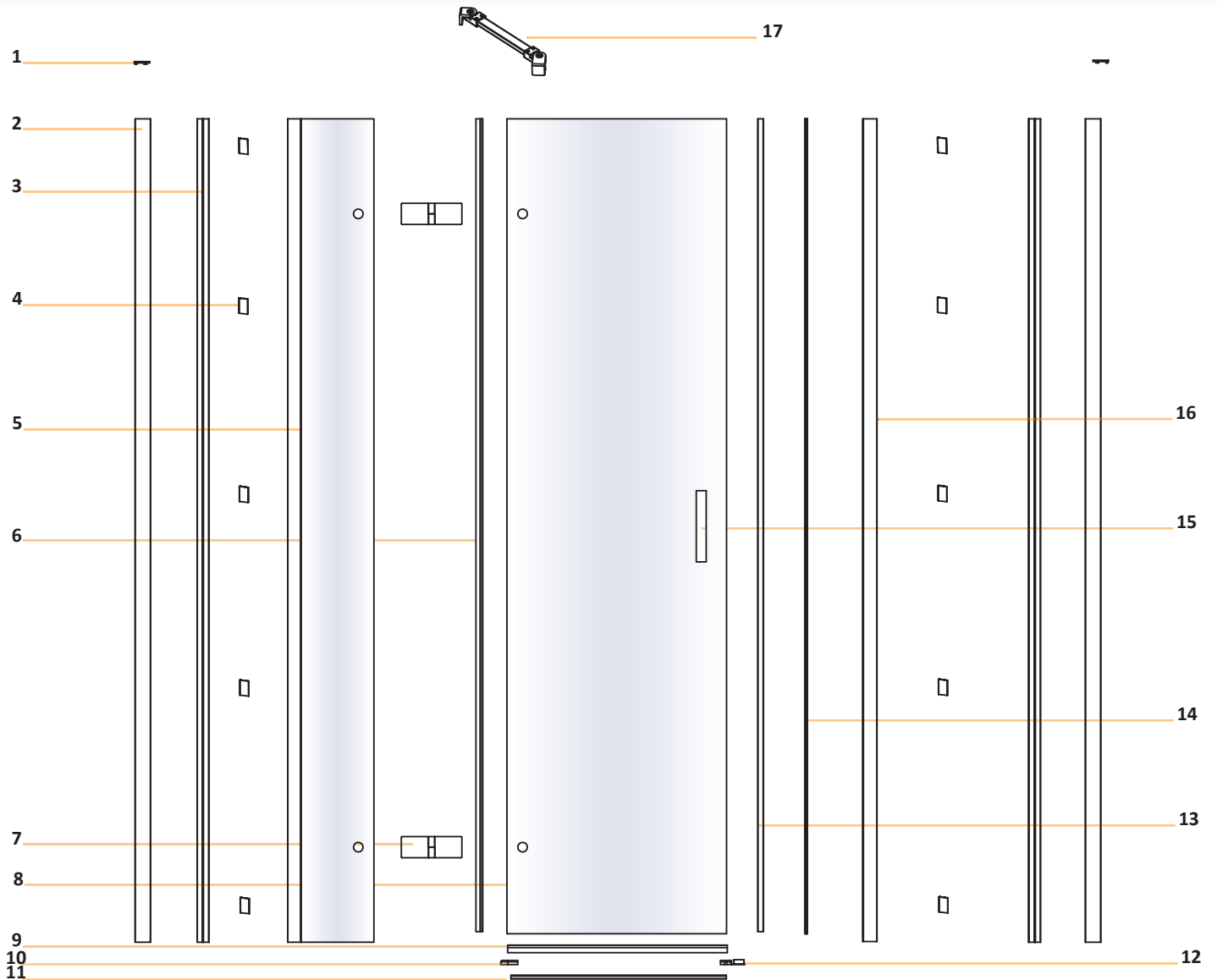

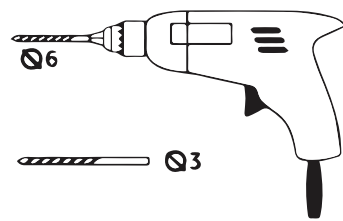
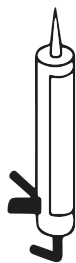
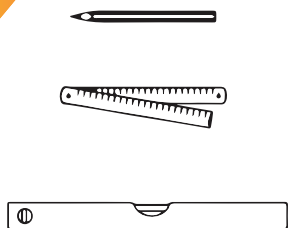

1

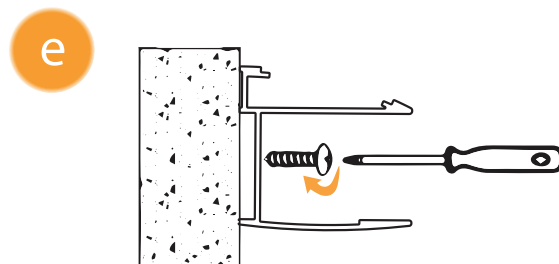
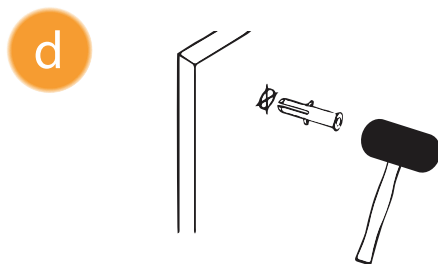
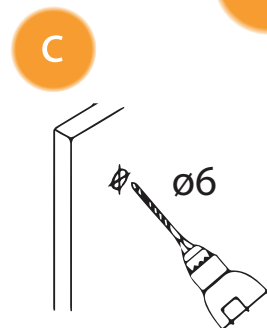
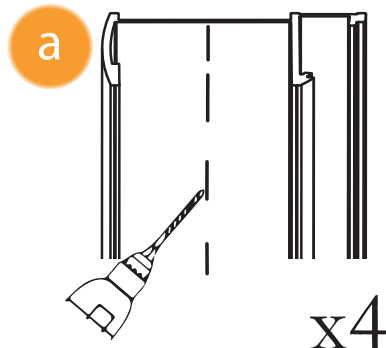
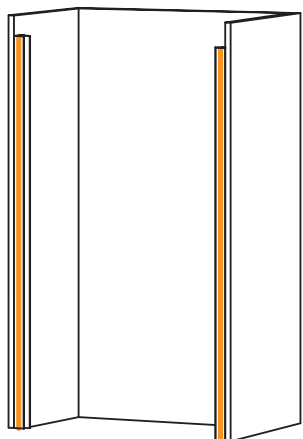

2

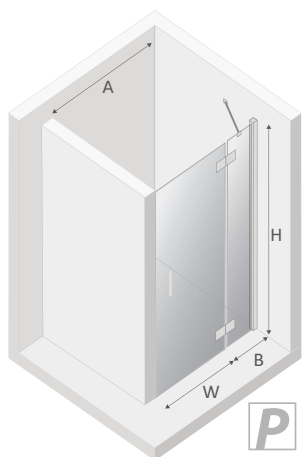

P

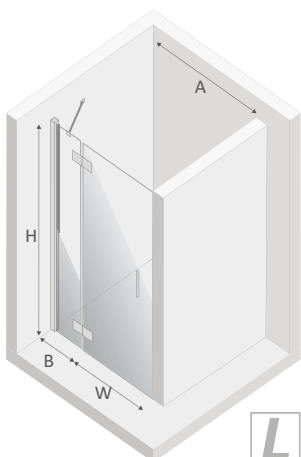

L



**TABELA NIE DOTYCZY KABIN NA WYMIAR!
THE TABLE DOES NOT INCLUDE CUSTOM-MADE ENCLOSURES!**

Gabaryty kabin **na wymiar** znajdują się na rysunku w zamówieniu.
Dimensions of the **custom-made** cabin are in the product order.

WYMIAR	A	B	W	H
80x195	79-82	21	53	195
90x195	89-92	31	53	195
100x195	99-102	31	63	195
110x195	109-112	41	63	195
120x195	119-122	51	63	195

3

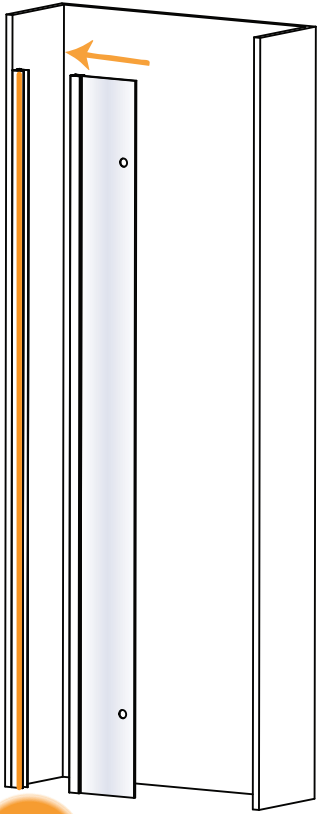

Active
Shield
INSIDE

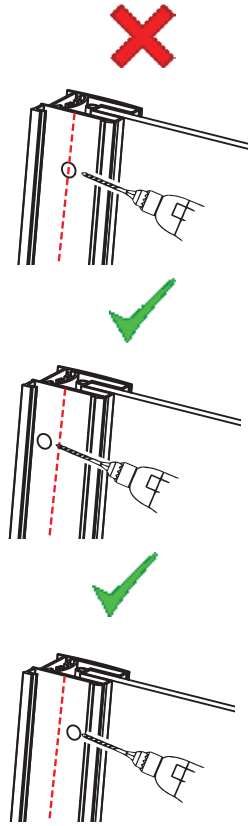

a

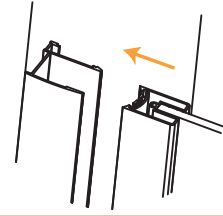

b

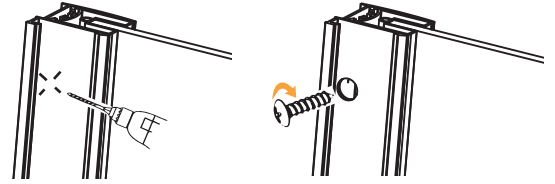

c

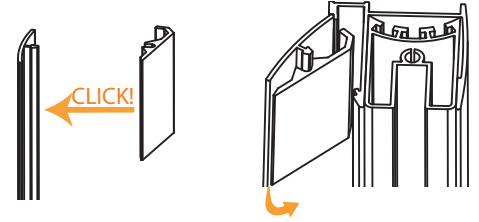

4

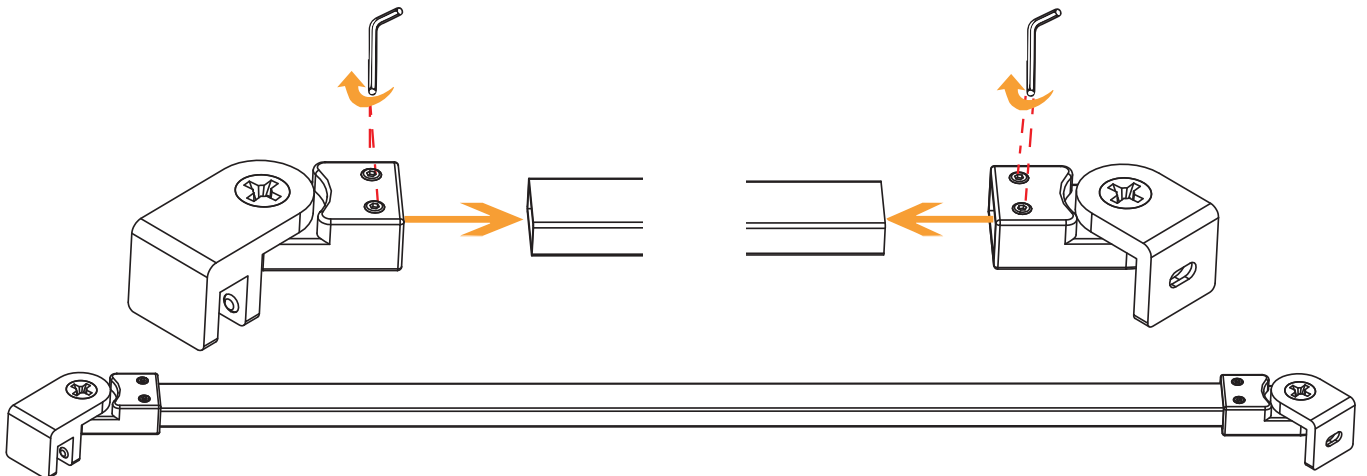
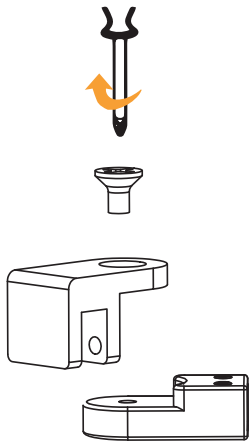

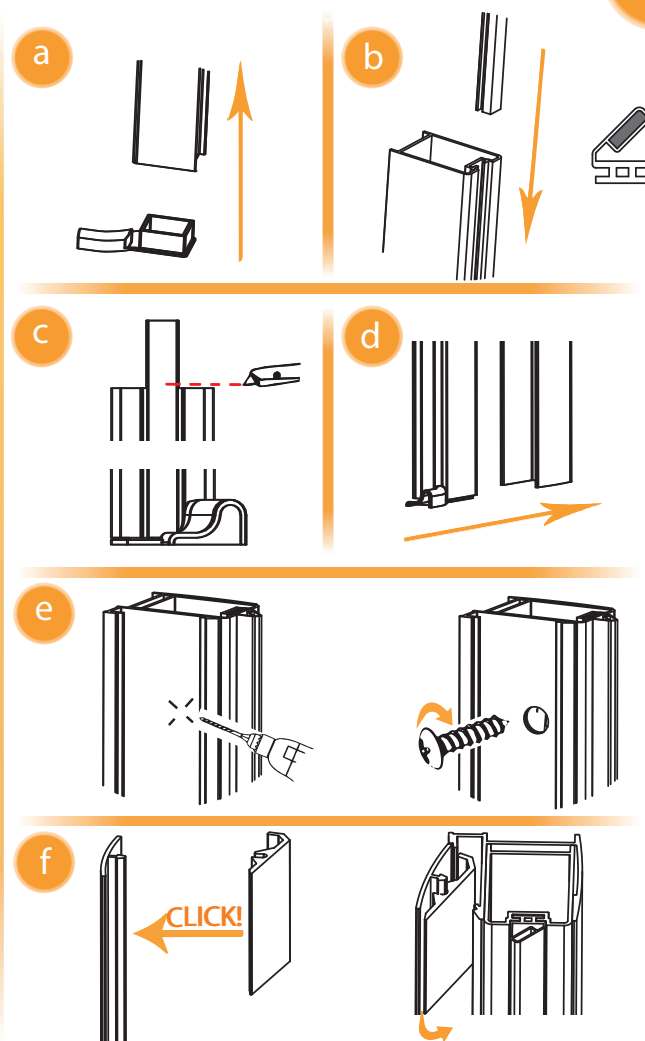
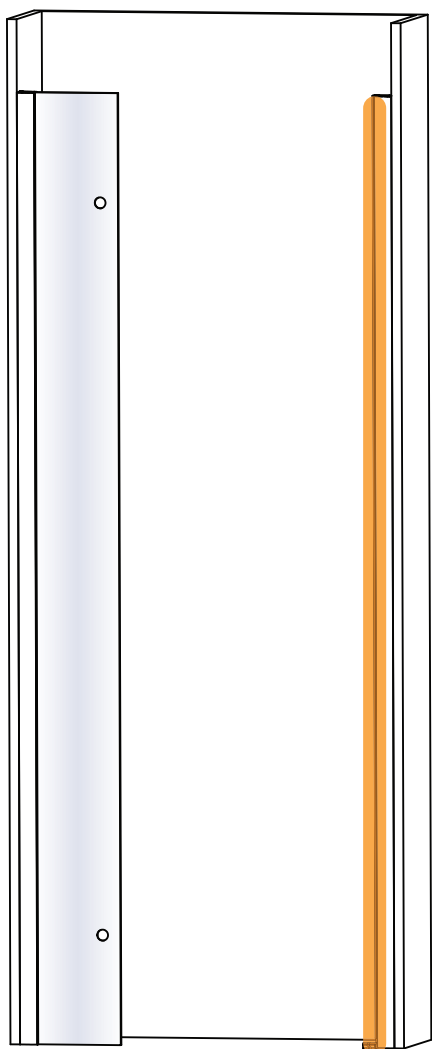
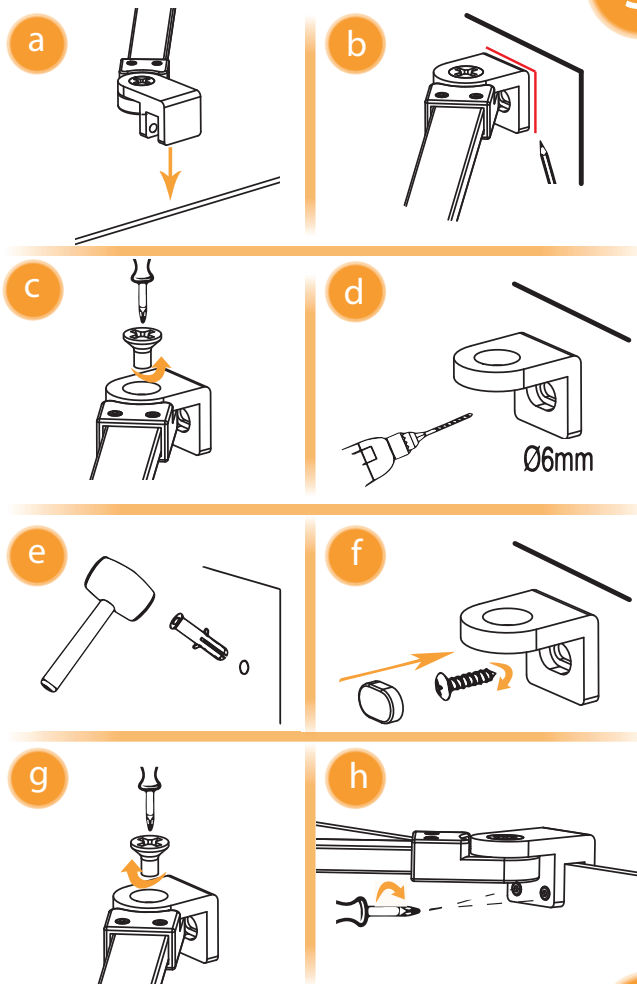
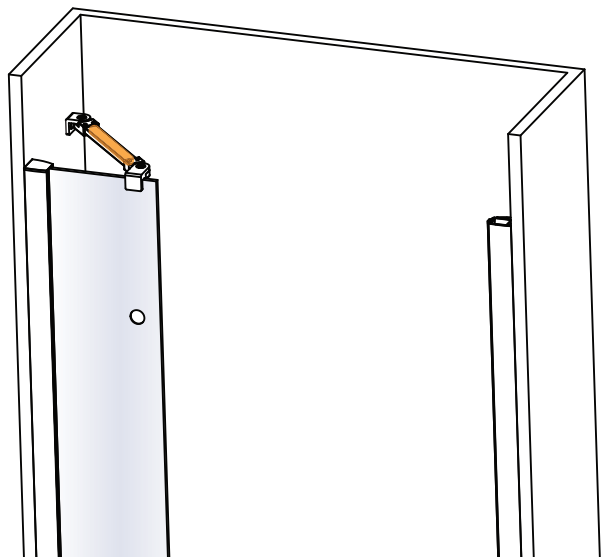
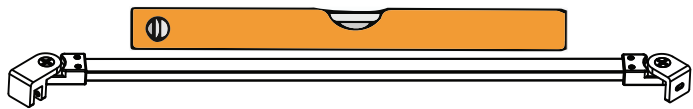

7

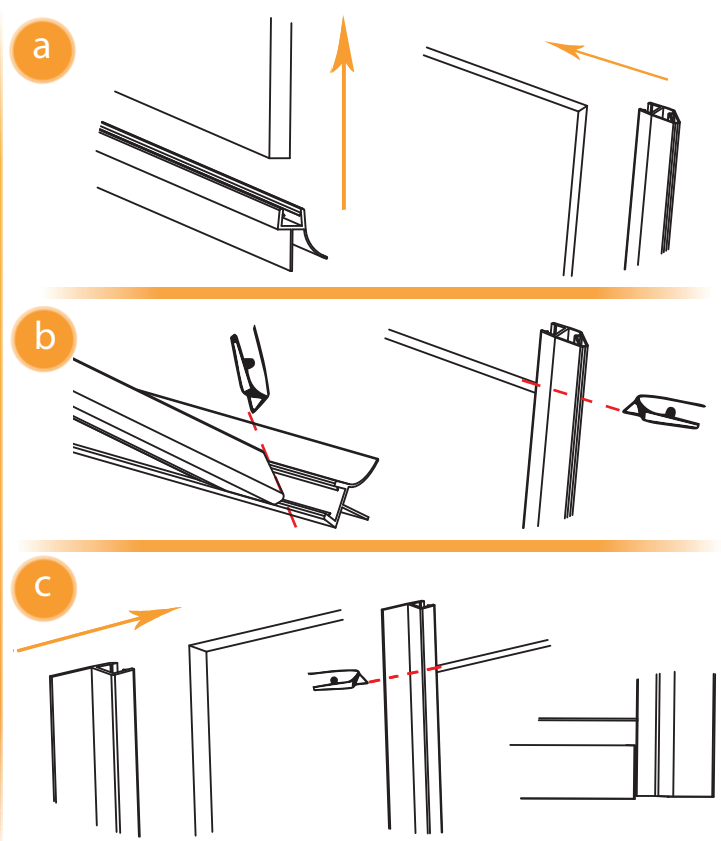
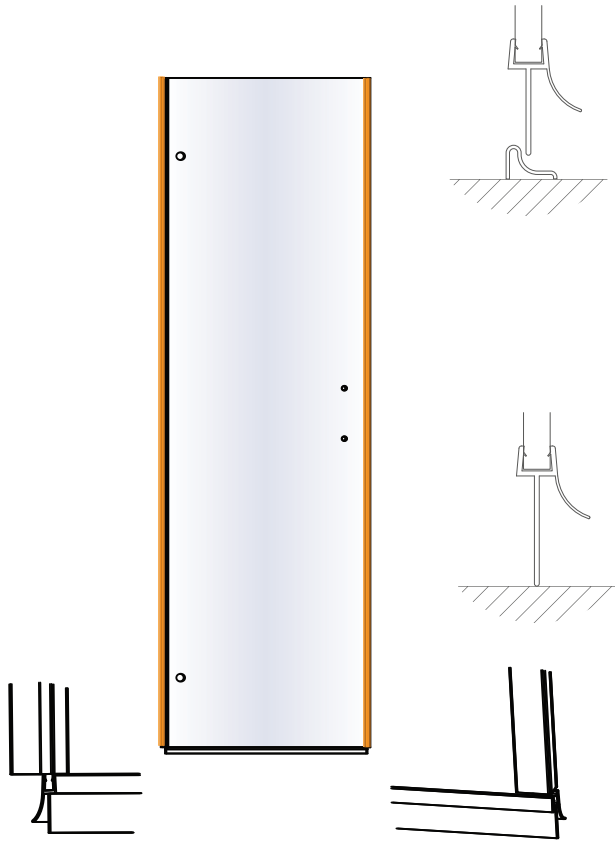

8

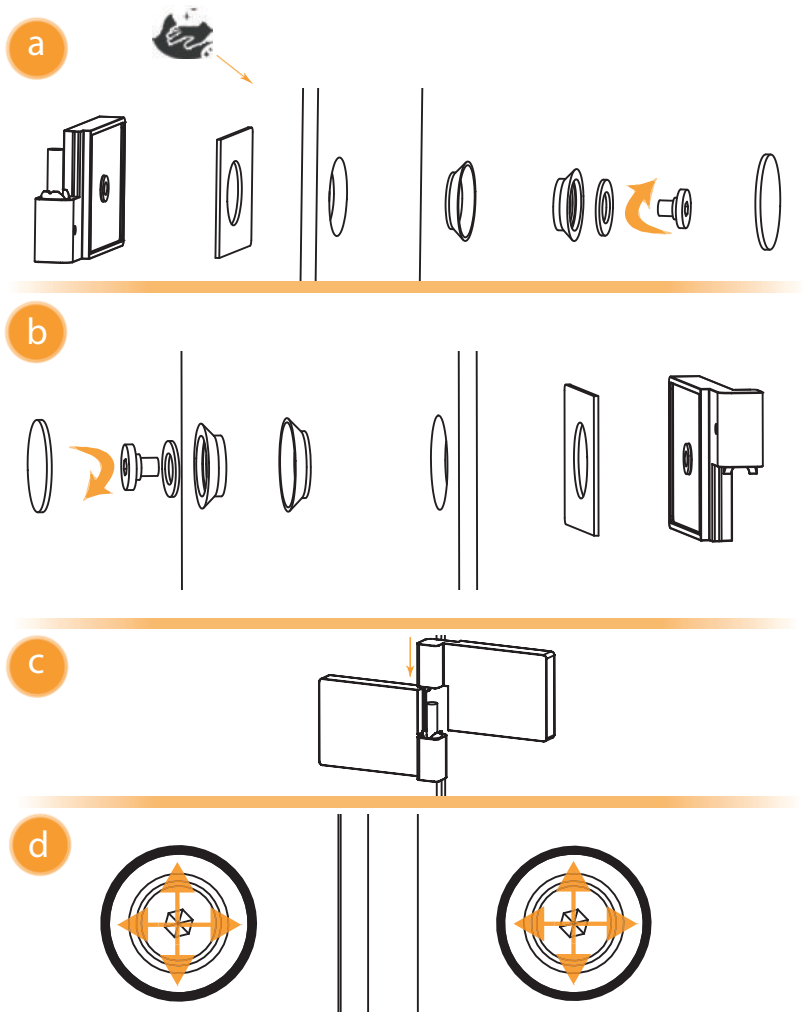
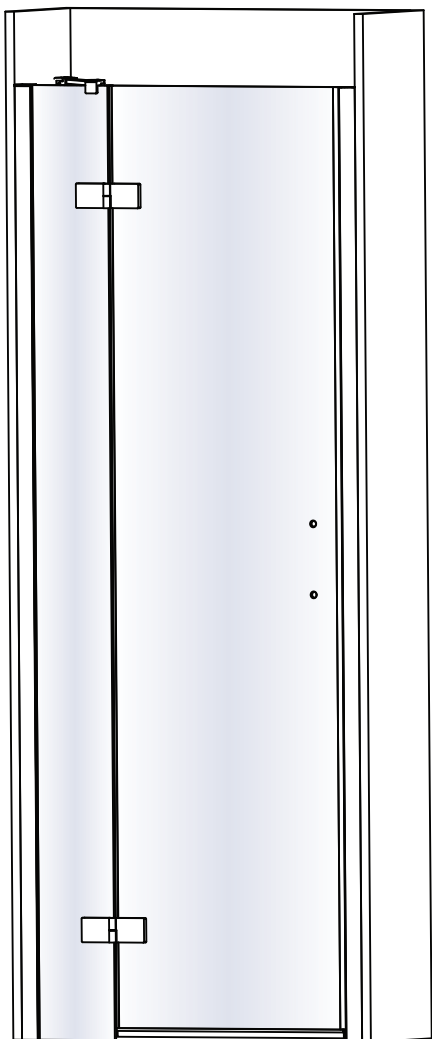

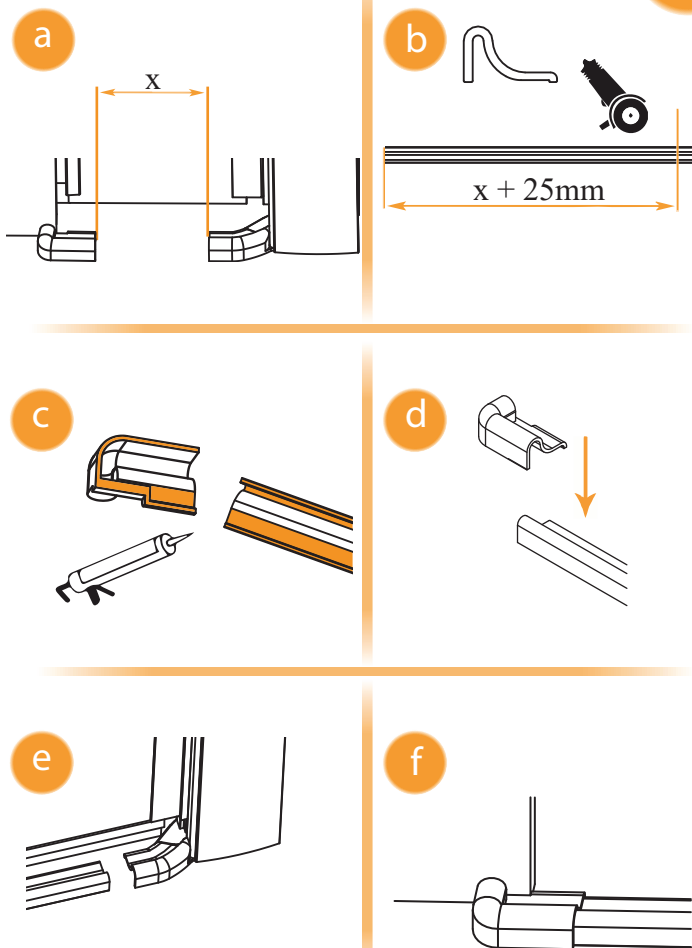
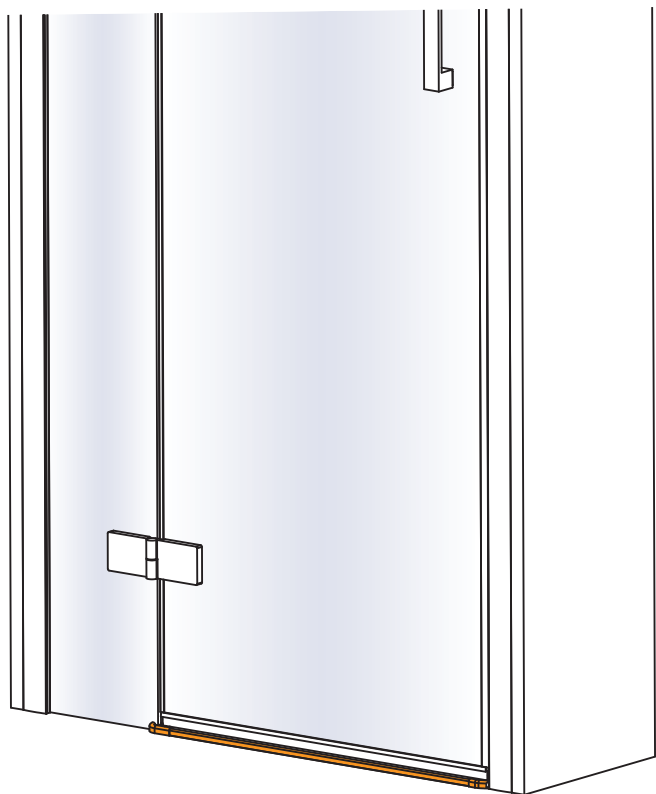
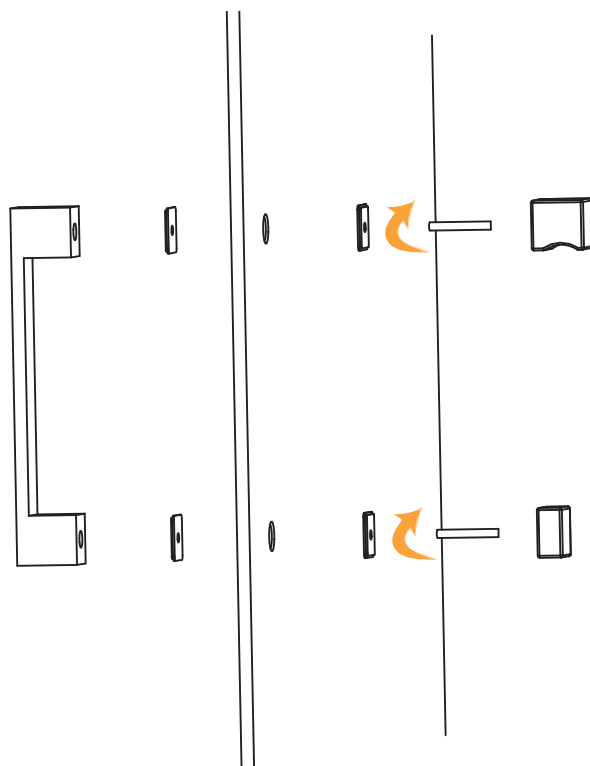
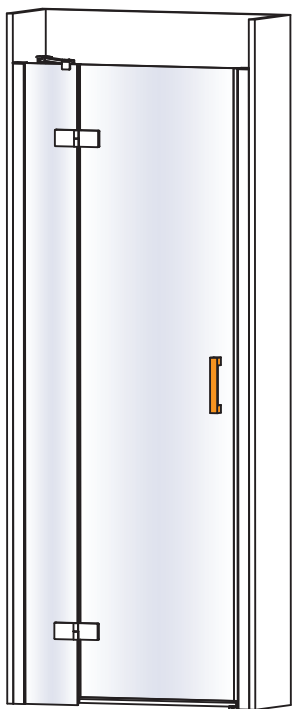

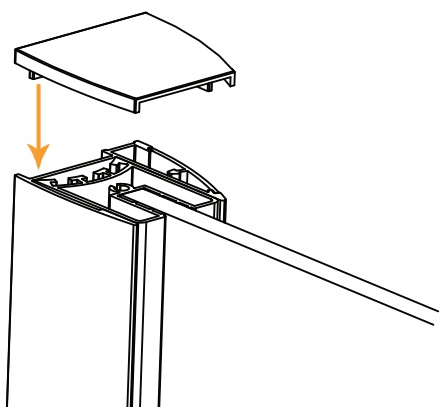

24H

