

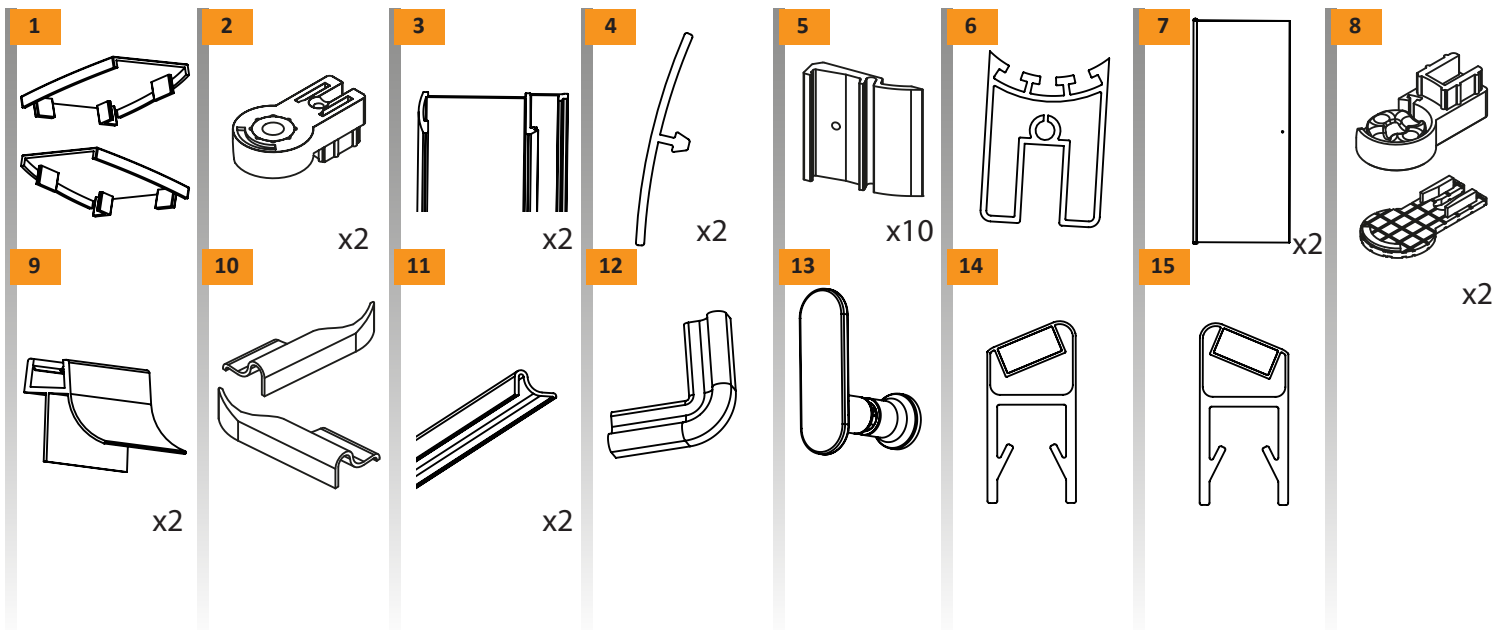

NEW SOLEO

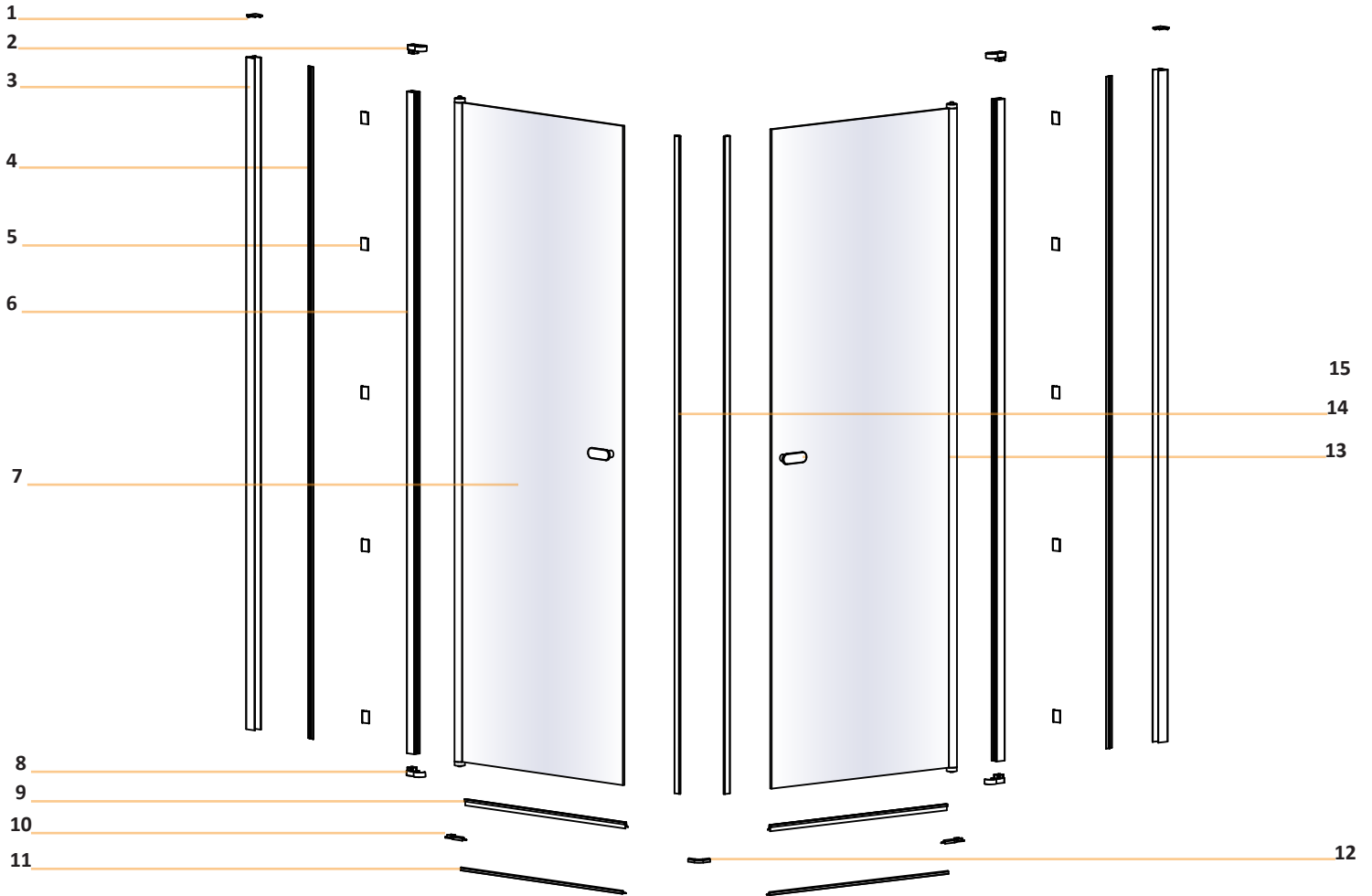

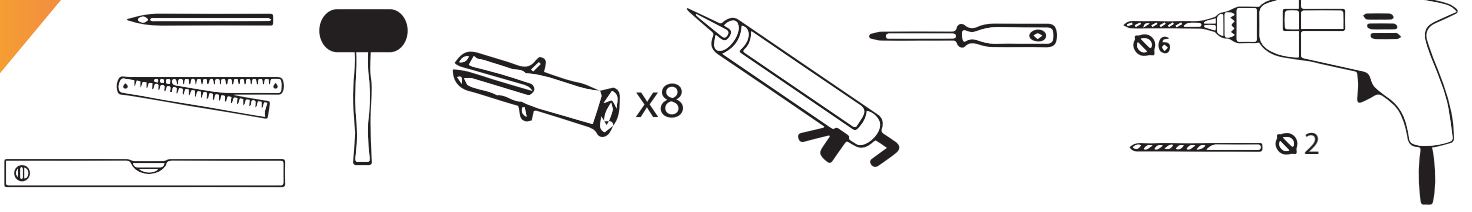

1

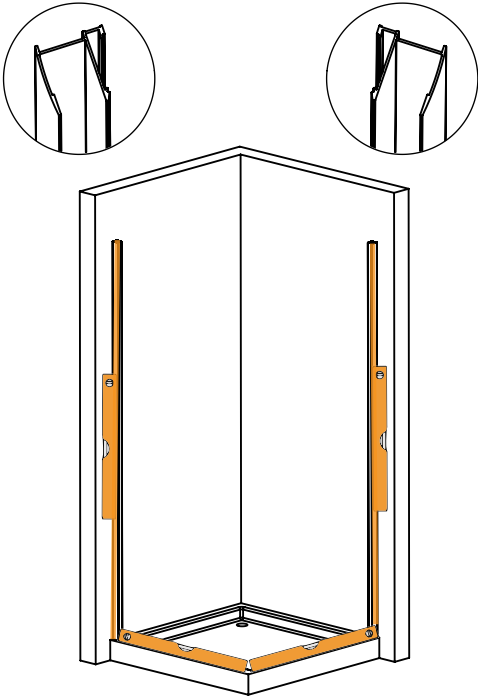

a

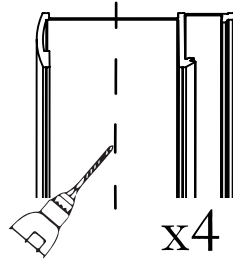

b

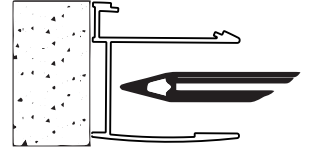

c

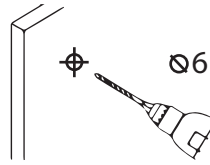

d

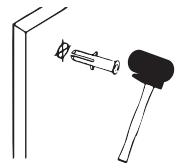

e

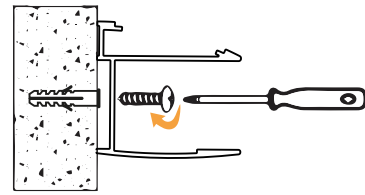

2

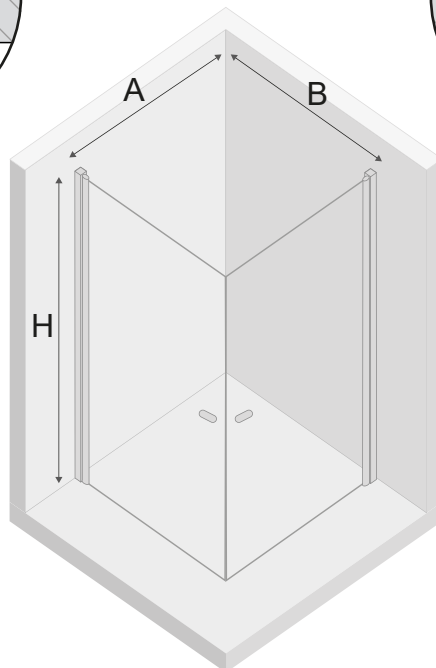
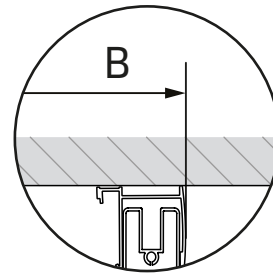
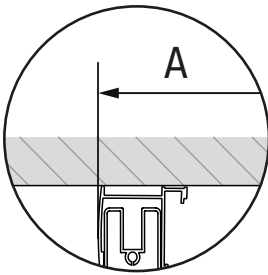



TABELA NIE DOTYCZY KABIN NA WYMIAR!
THE TABLE DOES NOT INCLUDE CUSTOM-MADE ENCLOSURES!

Specyfikacja techniczna **Kabin Na Wymiar** znajduje się w potwierdzeniu zamówienia.
The technical specification of the **Custom-Made Cabin** can be found in the order confirmation.

	Wymiary gabarytowe Overall dimensions		Wymiary do osi szyby Dimensions to the pane axis	
	A	B	X1	X2
70x70x195	68,5-70	68,5-70	67,2-68,7	67,2-68,7
70x80x195	68,5-70	78,5-80	67,2-68,7	77,2-78,7
70x90x195	68,5-70	88,5-90	67,2-68,7	87,2-88,7
70x100x195	68,5-70	98,5-100	67,2-68,7	97,2-98,7
80x80x195	78,5-80	78,5-80	77,2-78,7	77,2-78,7
80x90x195	78,5-80	88,5-90	77,2-78,7	87,2-88,7
80x100x195	78,5-80	98,5-100	77,2-78,7	97,2-98,7
90x90x195	88,5-90	88,5-90	87,2-88,7	87,2-88,7
90x100x195	88,5-90	98,5-100	87,2-88,7	97,2-98,7
100x100x195	98,5-100	98,5-100	97,2-98,7	97,2-98,7

3

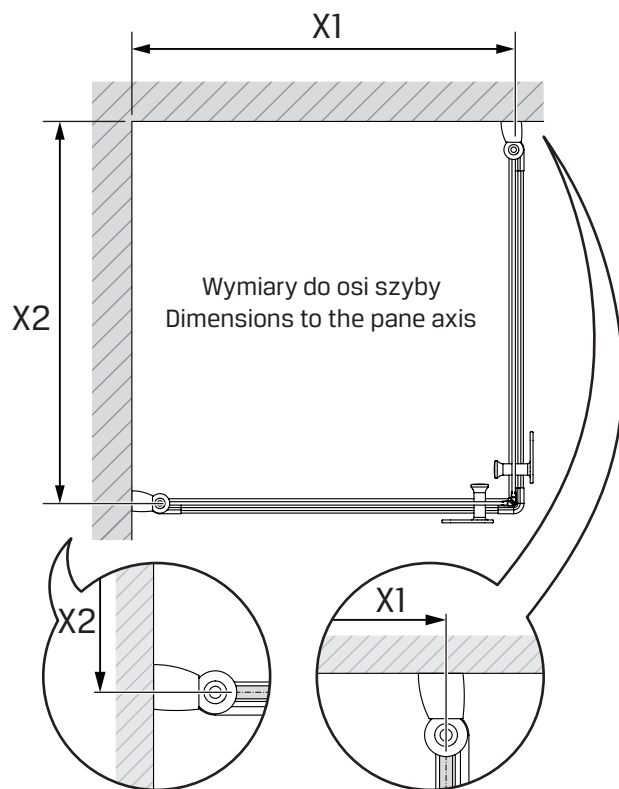
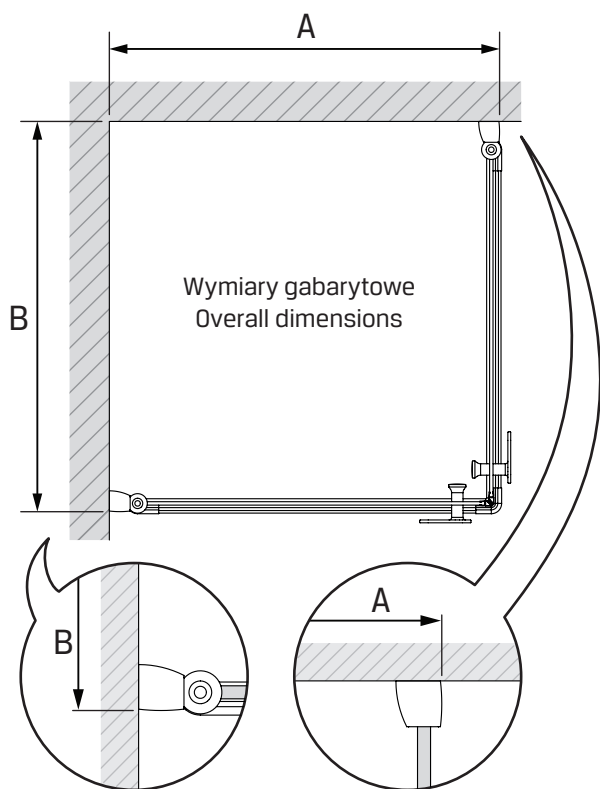
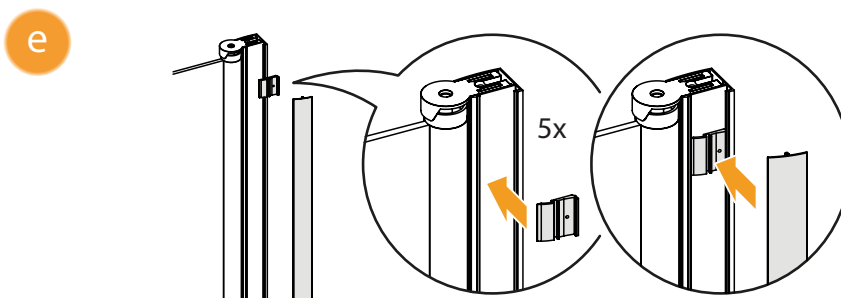
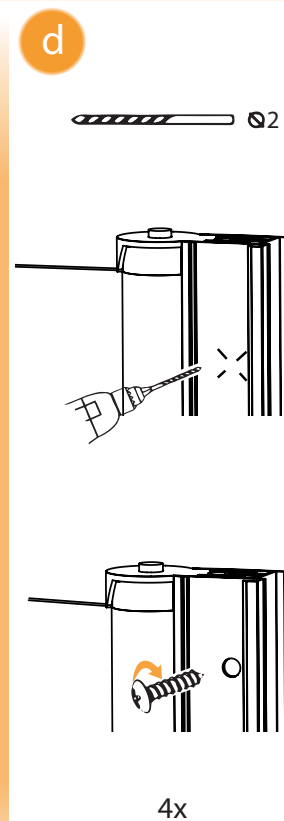
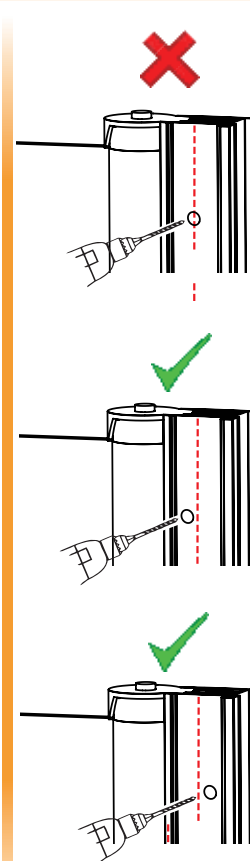
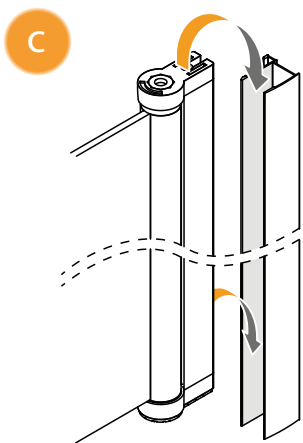
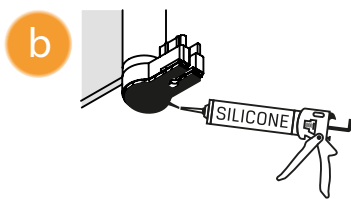
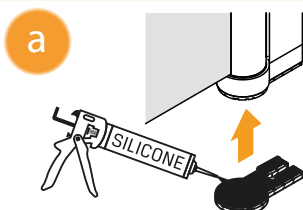
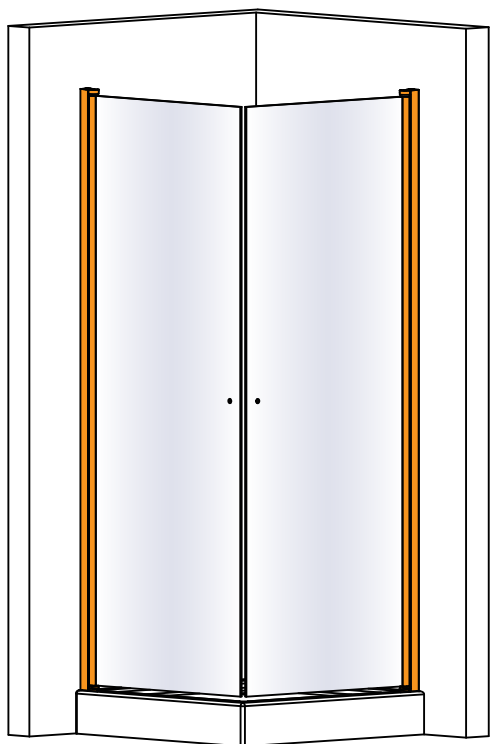

4

